

SEZ. A-A

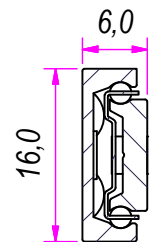

DESIGNED BY F.Dino	CHECKED AND APPROVED BY L. Paleari	GENERAL TOLLERANCE SS-ISO-2768-1M	DATE 08/01/2018	CODE 16150
		PACKAGING Carton 25 sets/Packed R+R	UNIT mm	SHEET 1 of 2
		DESCRIPTION Single extension Two-way travel	MATERIAL Aluminum PAIR WEIGHT 0,054 Kg 14C	
Guide per cassetti; guide telescopiche Coulisses à billes; coulisse télescopique Drawer slide; telescopic ball bearing slide Guías para cajones; guía teleópica Kugelführung; Teleskopschienen		REVISION HISTORY REV DESCRIPTION DATE 1a		08/01/2018 Without its written authorization the present drawing shall neither be used for construction anyway, communicated to third parties, nor reproduced.

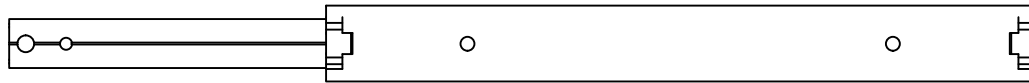

217,0

217,0

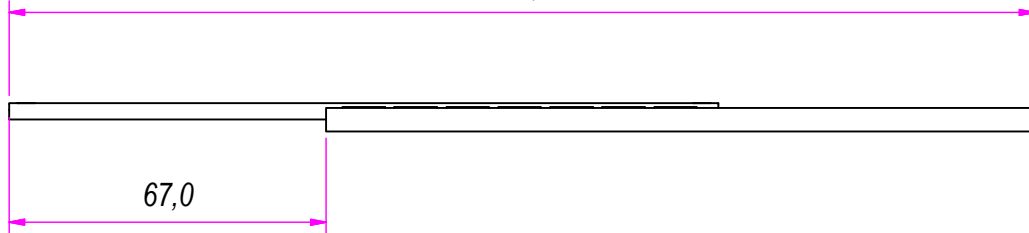

67,0

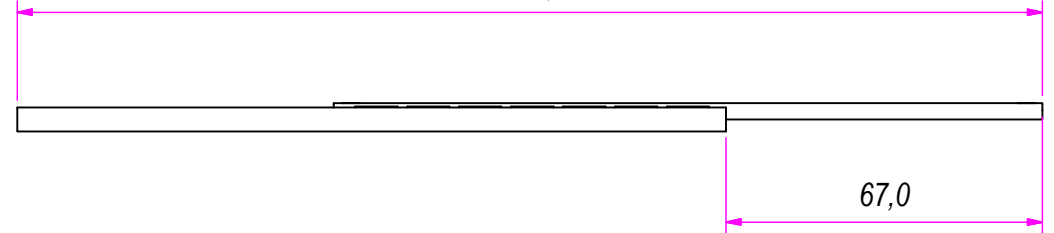

67,0

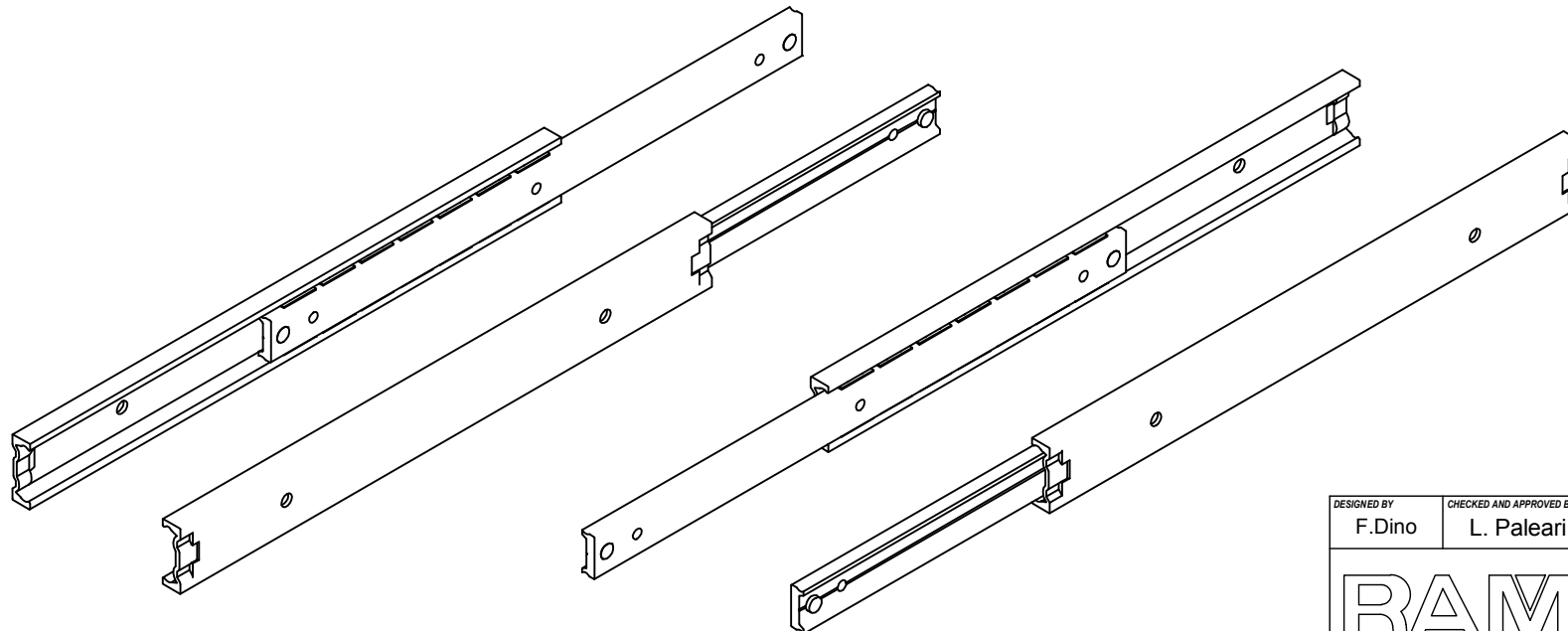
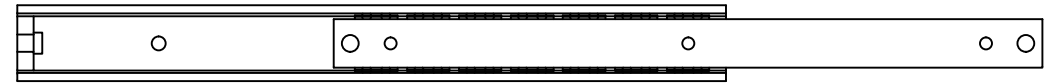
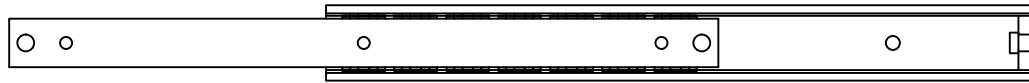

Guide per cassetti; guide telescopiche	Coulisses à billes; coulisse télescopique
Drawer slide; telescopic ball bearing slide	Guías para cajones; guía teleópica
Kugelführung; Teleskopschienen	

REVISION HISTORY	
REV	DESCRIPTION
1a	

DESIGNED BY F.Dino	CHECKED AND APPROVED BY L. Paleari	GENERAL TOLERANCE SS-ISO-2768-1M	DATE 08/01/2018	CODE 16150	
PACKAGING Carton 25 sets/Packed R+R			UNIT mm	SHEET 2 of 2	
			MATERIAL Aluminum		
			PAIR WEIGHT 0,054 Kg 14C		
DESCRIPTION Single extension Two-way travel			Property of RAM Industrie. Without its written authorization the present drawing shall neither be used for construction anyway, communicated to third parties, nor reproduced.		
		DATE 08/01/2018			