

REVISION HISTORY			
REV	DESCRIPTION	APPROVED BY	DATE
1		F.Dino	20/07/2020

DESIGNED BY F.Dino	CHECKED AND APPROVED BY L. Paleari	REVISION	DATE 20/07/2020	CODE 23350
		GENERAL TOLLERANCE SS-ISO-2768-1M	UNIT mm	SCALE SHEET 1 of 2
		DESCRIPTION Supplied screws	MATERIAL Cold rolled steel	
DEVICE Push and soft closing		PAIR WEIGHT 0,942 Kg	04C	

Property of RAM Industrie.  
Without its written authorization the present drawing shall neither be used for construction anyway, communicated to third parties, nor reproduced.

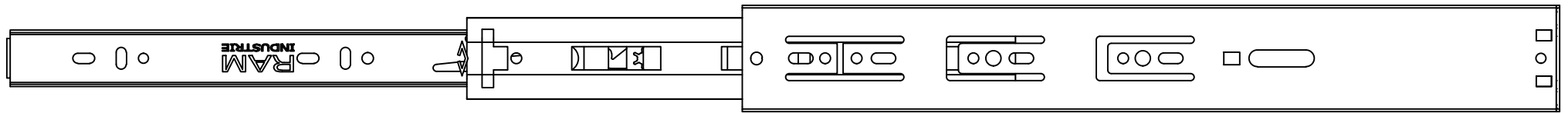

665,0

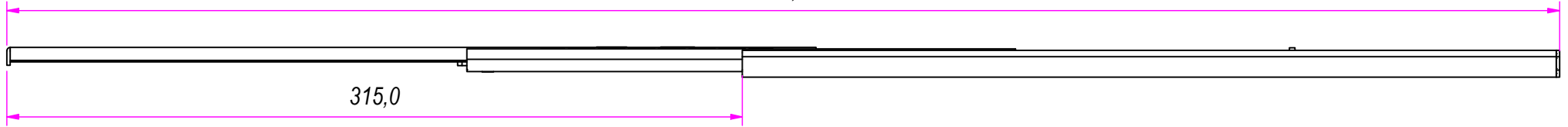

315,0

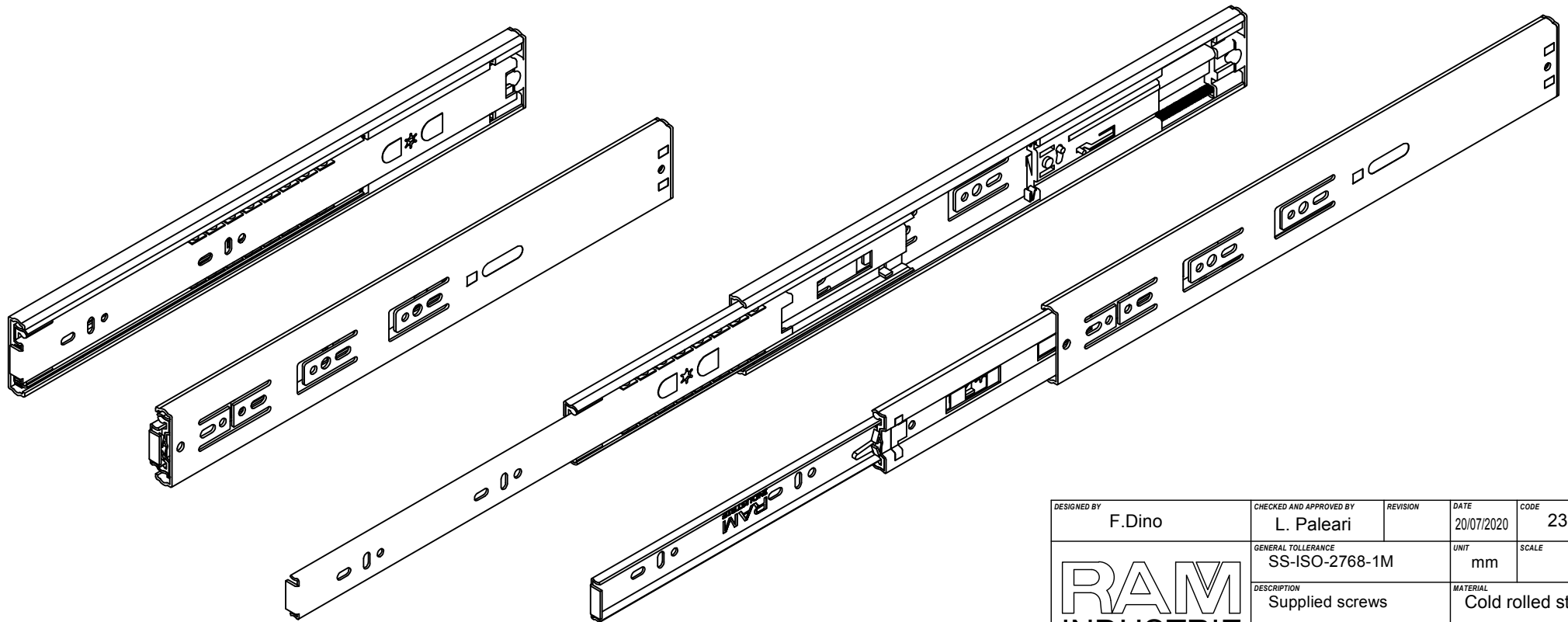

REVISION HISTORY			
REV	DESCRIPTION	APPROVED BY	DATE
1		F.Dino	20/07/2020

DESIGNED BY F.Dino	CHECKED AND APPROVED BY L. Paleari	REVISION	DATE 20/07/2020	CODE 23350
		GENERAL TOLLERANCE SS-ISO-2768-1M	UNIT mm	SCALE SHEET 2 of 2
		DESCRIPTION Supplied screws	MATERIAL Cold rolled steel	
		DEVICE Push and soft closing	PAIR WEIGHT 0,942 Kg	04C

Property of RAM Industrie.  
Without its written authorization the present drawing shall neither be used for construction anyway, communicated to third parties, nor reproduced.