

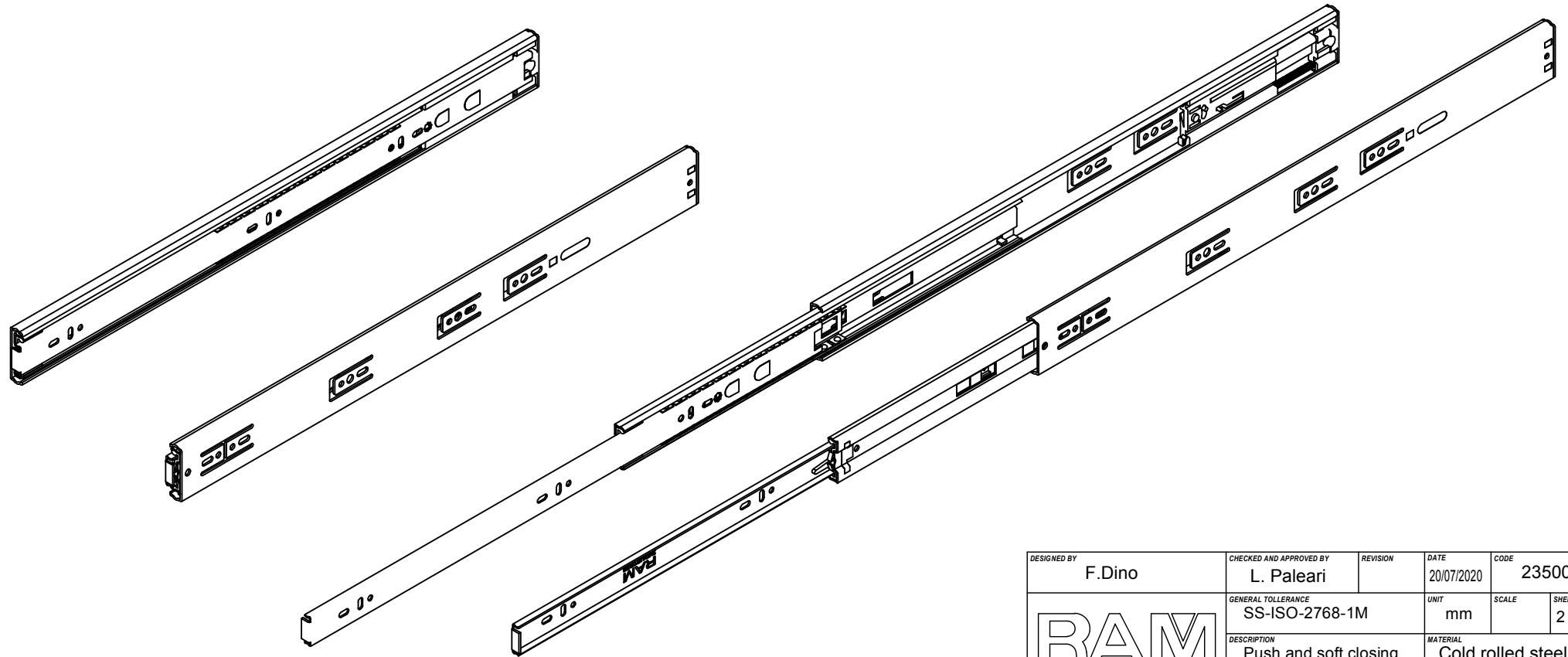

REVISION HISTORY			
REV	DESCRIPTION	APPROVED BY	DATE
1		F.Dino	20/07/2020

DESIGNED BY F.Dino	CHECKED AND APPROVED BY L. Paleari	REVISION	DATE 20/07/2020	CODE 23500
		GENERAL TOLLERANCE SS-ISO-2768-1M	UNIT mm	SCALE 1 of 2
		DESCRIPTION Push and soft closing	MATERIAL Cold rolled steel	
DEVICE			PAIR WEIGHT 1,392 Kg	
<small>Property of RAM Industrie. Without its written authorization the present drawing shall neither be used for construction anyway, communicated to third parties, nor reproduced.</small>				

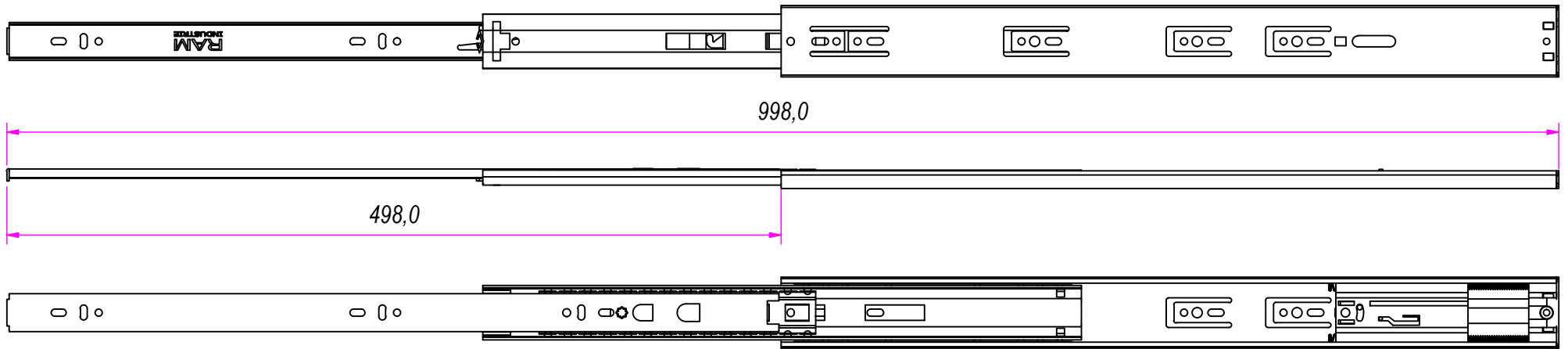

REVISION HISTORY			
REV	DESCRIPTION	APPROVED BY	DATE
1		F.Dino	20/07/2020

DESIGNED BY F.Dino	CHECKED AND APPROVED BY L. Paleari	REVISION	DATE 20/07/2020	CODE 23500
		GENERAL TOLLERANCE SS-ISO-2768-1M	UNIT mm	SCALE SHEET 2 of 2
		DESCRIPTION Push and soft closing	MATERIAL Cold rolled steel	
DEVICE		PAIR WEIGHT 1,392 Kg		

Property of RAM Industrie.
Without its written authorization the present drawing shall neither be used for construction anyway, communicated to third parties, nor reproduced.