

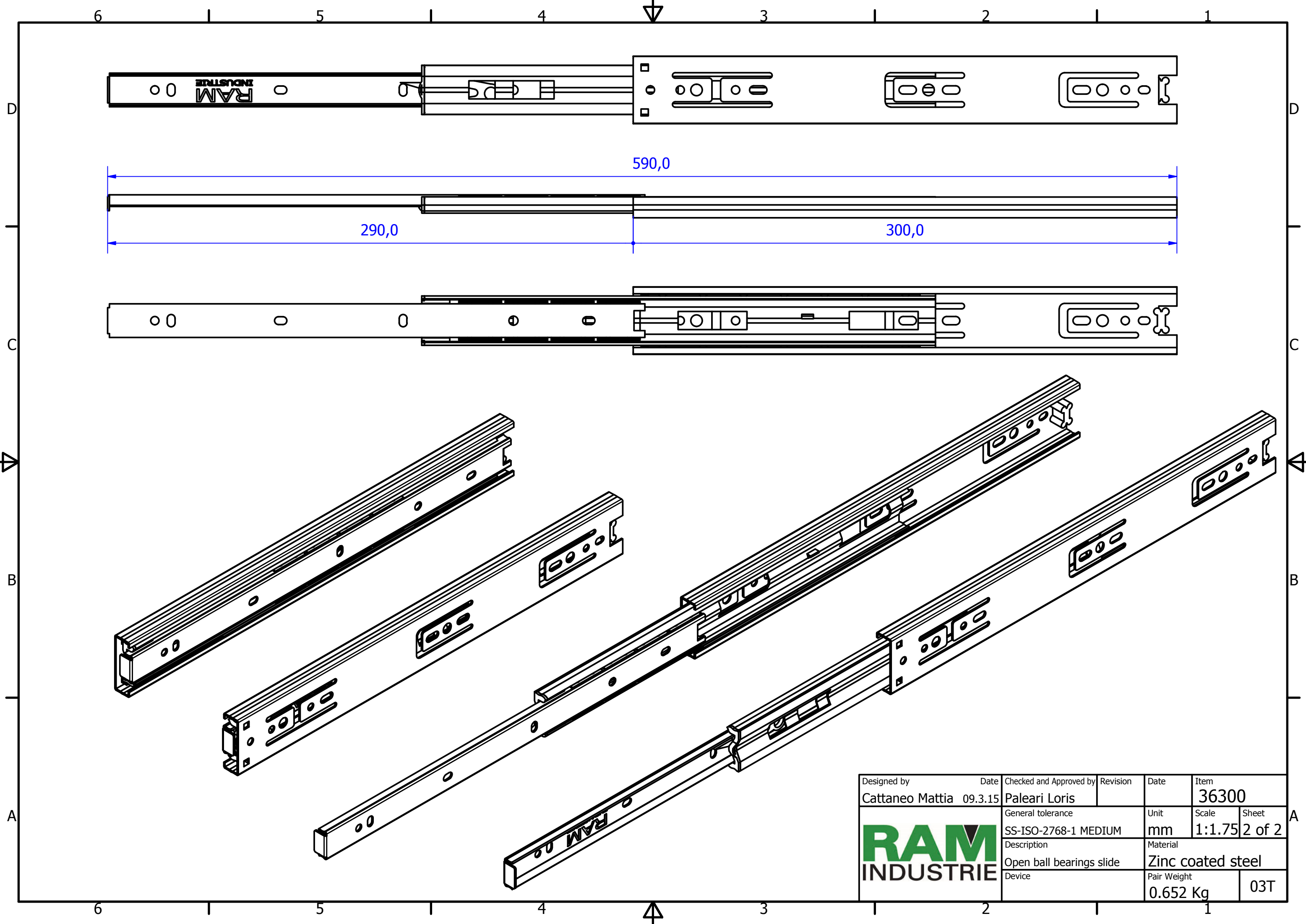

Designed by Cattaneo Mattia	Date 09.3.15	Checked and Approved by Paleari Loris	Revision	Date	Item 36300
			General tolerance SS-ISO-2768-1 MEDIUM	Unit mm	Scale 1:1
			Description Closed ball bearings slide	Material Zinc coated steel	
Device				Pair Weight 0.652 Kg	03T



Designed by Cattaneo Mattia	Date 09.3.15	Checked and Approved by Paleari Loris	Revision	Date	Item 36300
		General tolerance SS-ISO-2768-1 MEDIUM	Unit mm	Scale 1:1.75	Sheet 2 of 2
		Description Open ball bearings slide	Material Zinc coated steel		
Device		Pair Weight 0.652 Kg	03T		