

SEZ. A-A

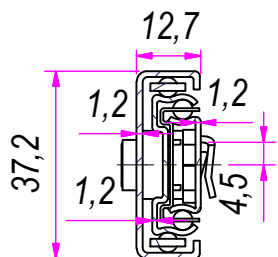

B (1 : 1,5)

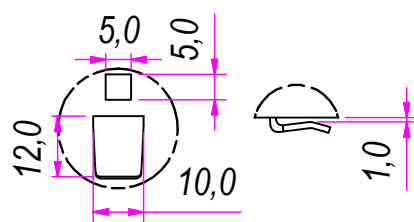

C (1 : 1)

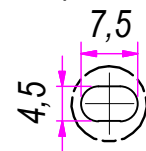

REVISION HISTORY			
REV	DESCRIPTION	APPROVED BY	DATE
1	Added teeth	F.Dino	03/11/2016

DESIGNED BY F.Dino	CHECKED AND APPROVED BY L. Paleari	DATE 03/11/2016	CODE 37500	
		GENERAL TOLERANCE SS-ISO-2768-1M	UNIT mm	SCALE 1 of 2
		DESCRIPTION Bayonet side mounting	MATERIAL Cold rolled steel	
DEVICE		PAIR WEIGHT 1,26 Kg	02C	
Property of RAM Industrie. Without its written authorization the present drawing shall neither be used for construction anyway, communicated to third parties, nor reproduced.				

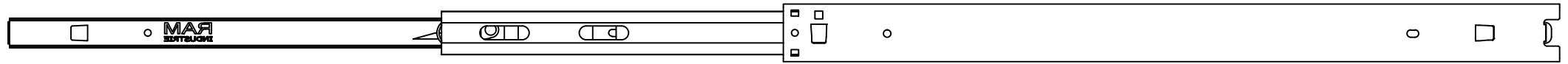

1000,0

500,0

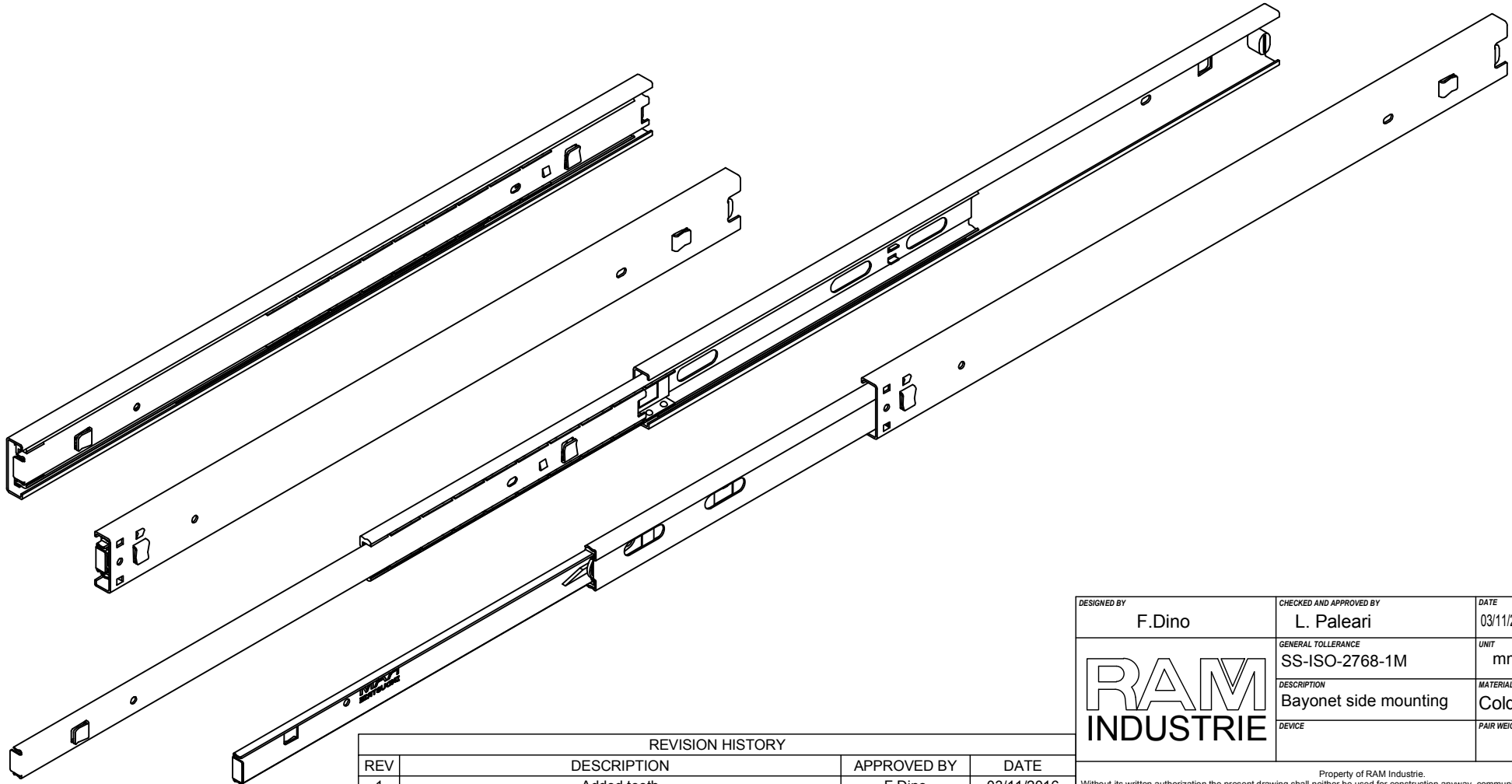
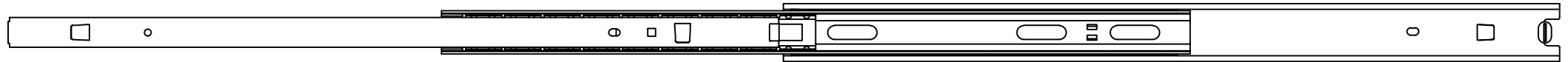
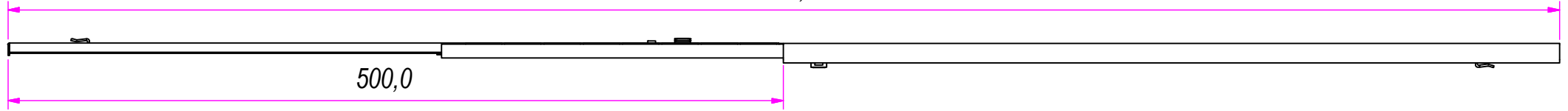

REVISION HISTORY			
REV	DESCRIPTION	APPROVED BY	DATE
1	Added teeth	F.Dino	03/11/2016

DESIGNED BY F.Dino	CHECKED AND APPROVED BY L. Paleari	DATE 03/11/2016	CODE 37500	
		GENERAL TOLLERANCE SS-ISO-2768-1M	UNIT mm	SCALE SHEET 2 of 2
		DESCRIPTION Bayonet side mounting	MATERIAL Cold rolled steel	PAIR WEIGHT 1,26 Kg

Property of RAM Industrie.
Without its written authorization the present drawing shall neither be used for construction anyway, communicated to third parties, nor reproduced.