

SEZ. A-A

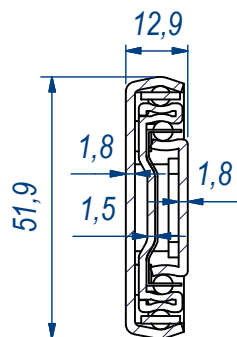

B (1:1)

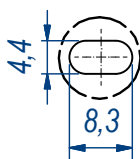

C (1:1)

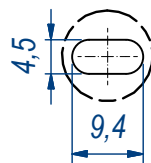

D (1:1)

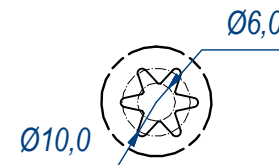

DESIGNED BY <b>F.Dino</b>	CHECKED AND APPROVED BY <b>L. Paleari</b>	REVISION	DATE 16/03/2016	CODE 45600
<b>RAM</b> <b>INDUSTRIE</b>		GENERAL TOLERANCE SS-ISO-2768-1M	UNIT mm	SCALE 1 of 2
		DESCRIPTION	MATERIAL Cold rolled steel	
DEVICE Push and rebound system		PAIR WEIGHT 2,684 Kg	01T	

Property of RAM Industrie.  
Without its written authorization the present drawing shall neither be used for construction anyway, communicated to third parties, nor reproduced.

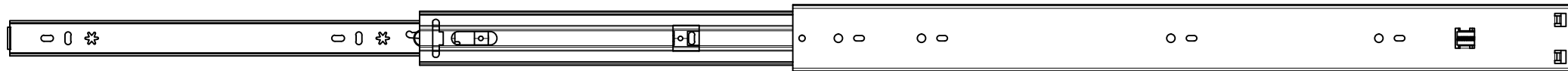

1211,0

611,0

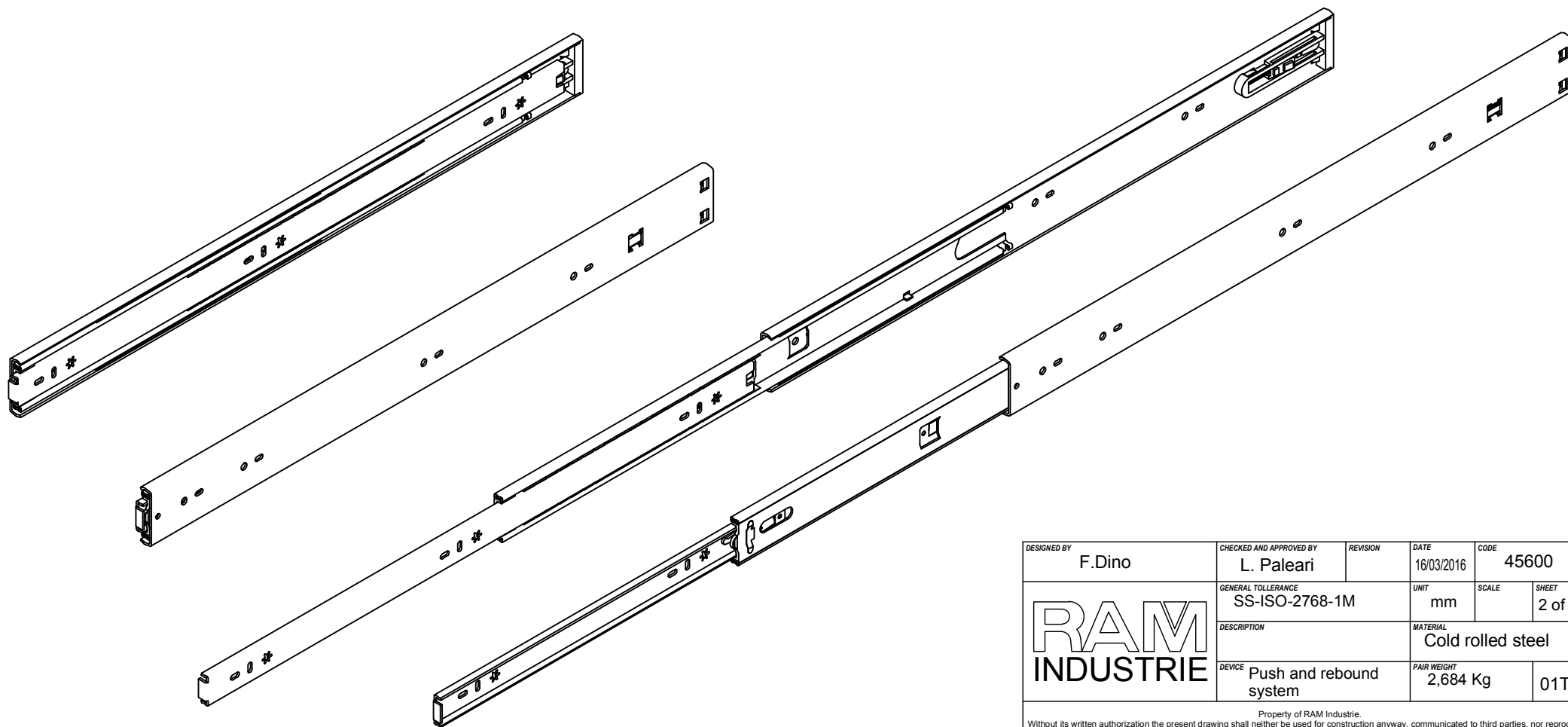
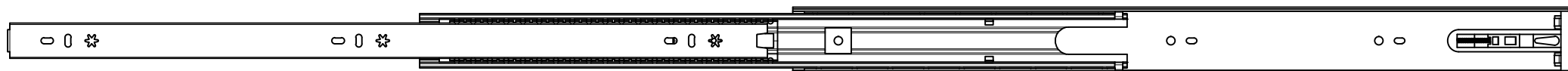
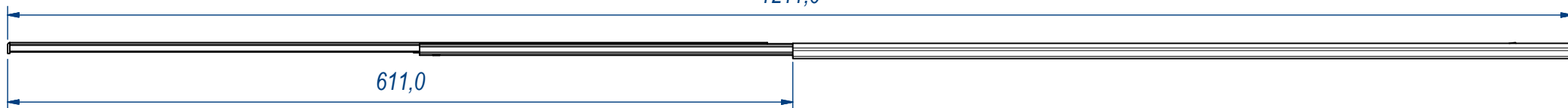

DESIGNED BY F.Dino	CHECKED AND APPROVED BY L. Paleari	REVISION	DATE 16/03/2016	CODE 45600
		GENERAL TOLLERANCE SS-ISO-2768-1M	UNIT mm	SCALE SHEET 2 of 2
		DESCRIPTION	MATERIAL Cold rolled steel	
DEVICE Push and rebound system		PAIR WEIGHT 2,684 Kg	01T	

Property of RAM Industrie.  
Without its written authorization the present drawing shall neither be used for construction anyway, communicated to third parties, nor reproduced.