

400,0

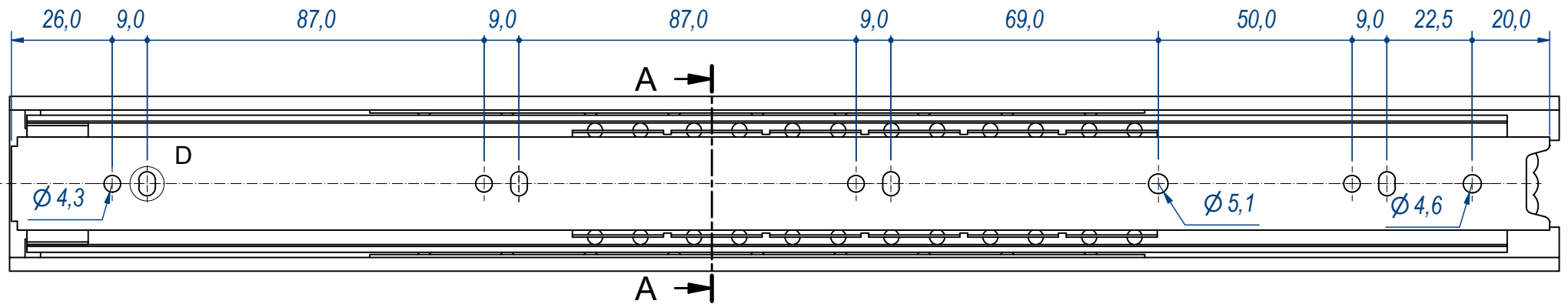

SEZ. A-A

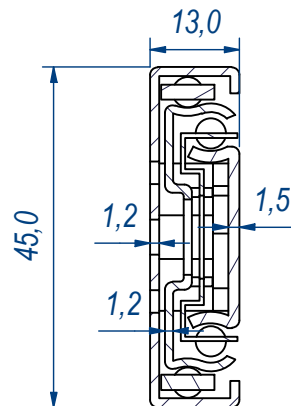

B (1:1)

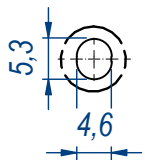

C (1:1)

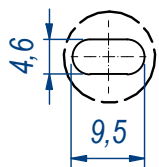

D (1:1)

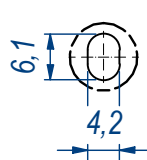

DESIGNED BY F.Dino	CHECKED AND APPROVED BY L. Paleari	REVISION	DATE 07/03/2016	CODE 46400
GENERAL TOLERANCE SS-ISO-2768-1M			UNIT mm	SCALE 1 of 2
DESCRIPTION			MATERIAL Cold rolled steel	
DEVICE			PAIR WEIGHT 1,222 Kg	03T

Property of RAM Industrie.
Without its written authorization the present drawing shall neither be used for construction anyway, communicated to third parties, nor reproduced.

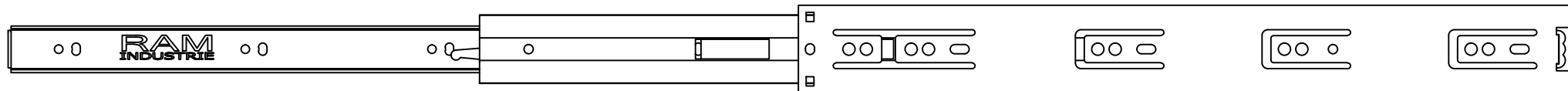

807,0



407,0

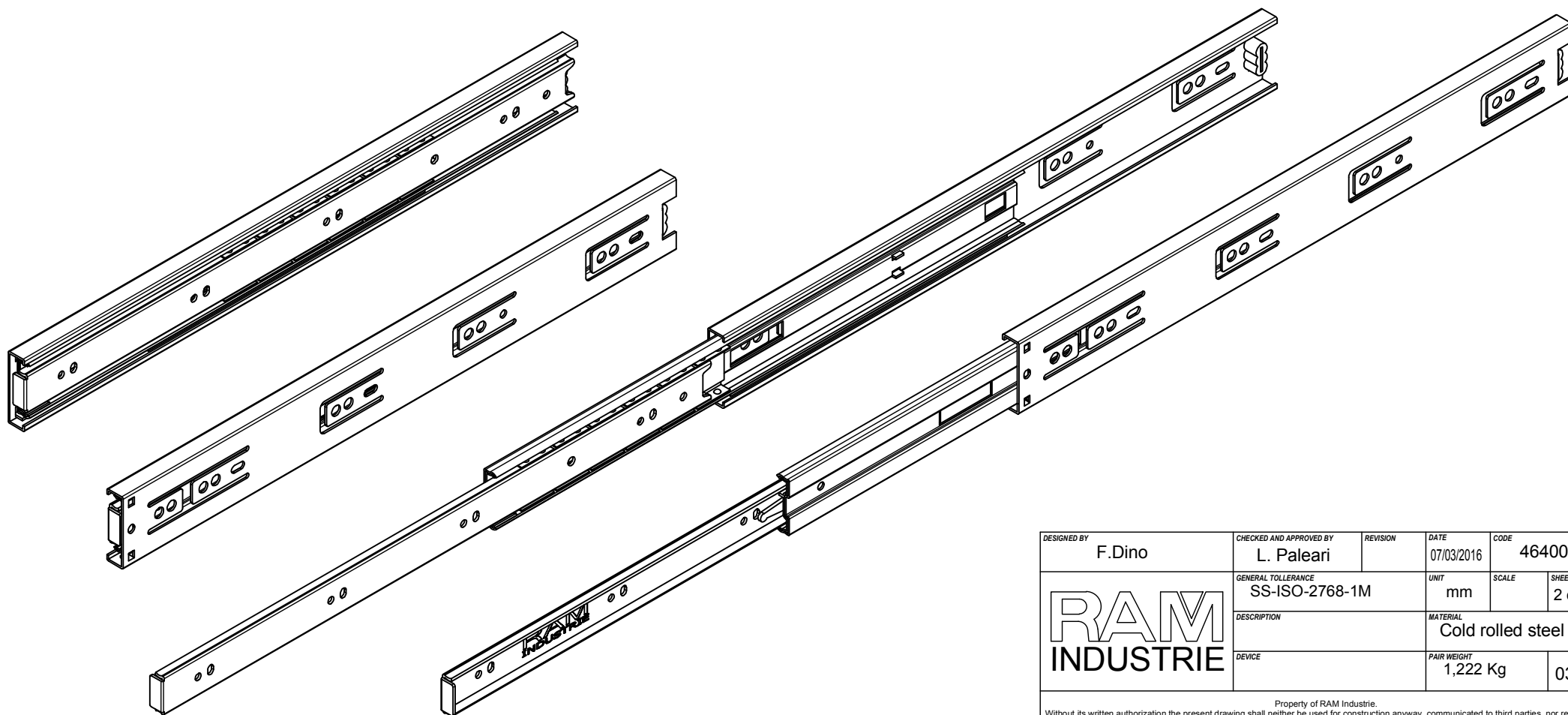
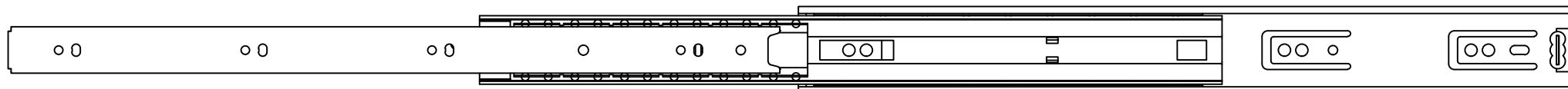

DESIGNED BY F.Dino	CHECKED AND APPROVED BY L. Paleari	REVISION	DATE 07/03/2016	CODE 46400
GENERAL TOLERANCE SS-ISO-2768-1M		UNIT mm	SCALE	SHEET 2 of 2
DESCRIPTION RAM INDUSTRIE			MATERIAL Cold rolled steel	
DEVICE		PAIR WEIGHT 1,222 Kg	03T	

Property of RAM Industrie.
Without its written authorization the present drawing shall neither be used for construction anyway, communicated to third parties, nor reproduced.