

SEZ. A-A

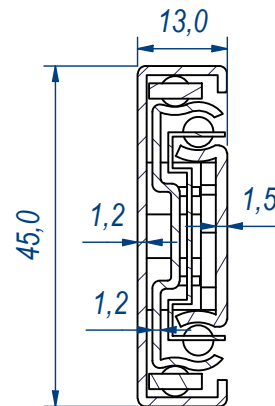

B (1:1)

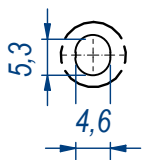

C (1:1)

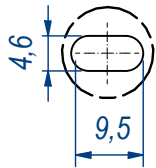

D (1:1)

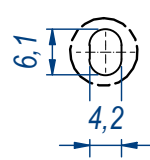

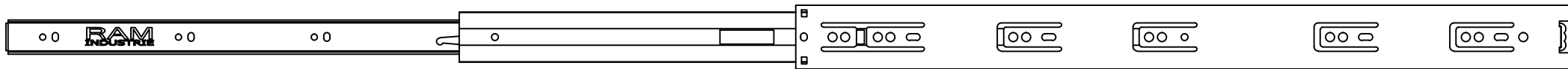

DESIGNED BY <b>F.Dino</b>	CHECKED AND APPROVED BY <b>L. Paleari</b>	REVISION	DATE 07/03/2016	CODE 46550
		GENERAL TOLERANCE SS-ISO-2768-1M	UNIT mm	SCALE 1 of 2
		DESCRIPTION	MATERIAL Cold rolled steel	
DEVICE	PAIR WEIGHT 1,696 Kg	03T		

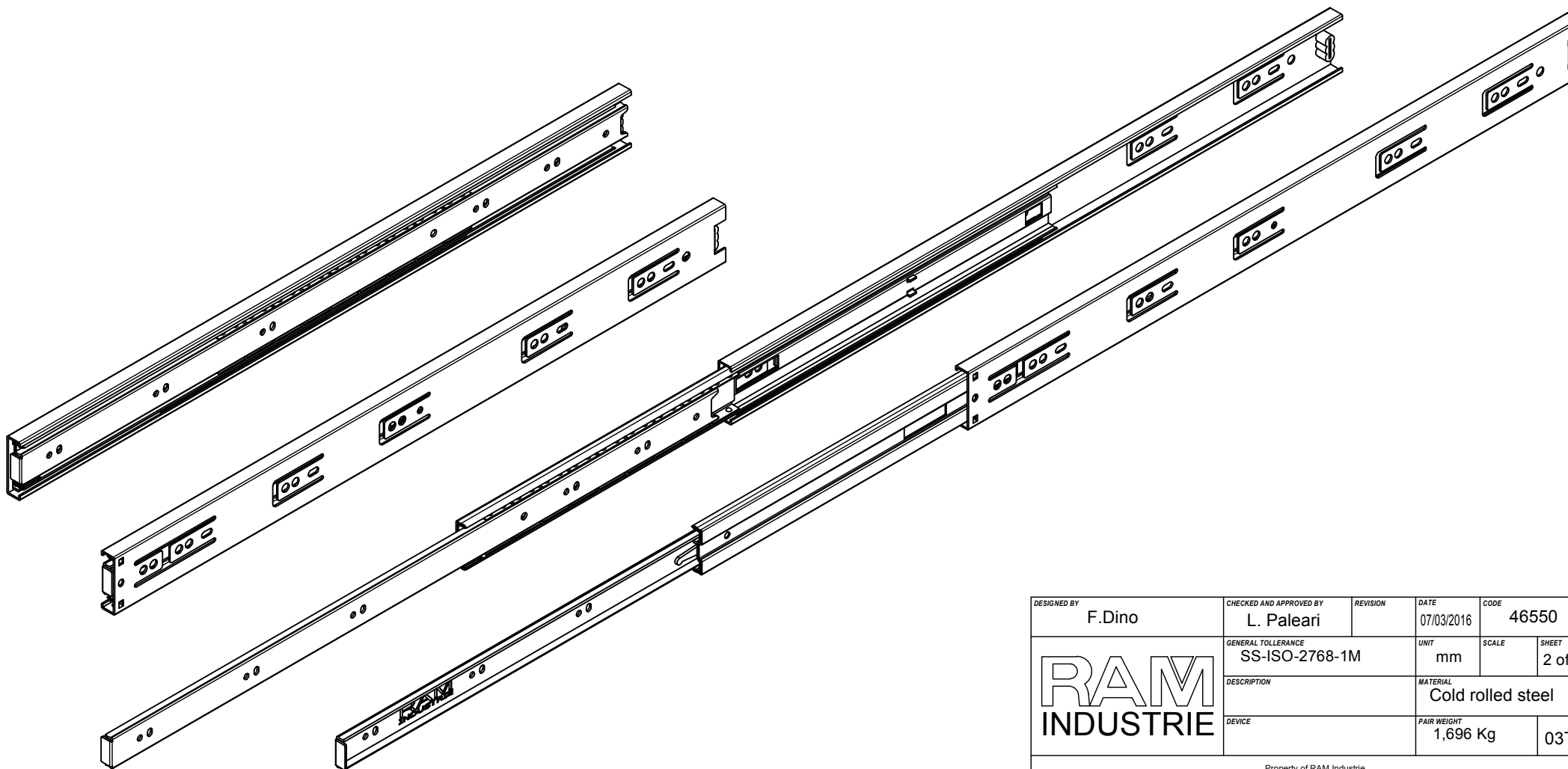
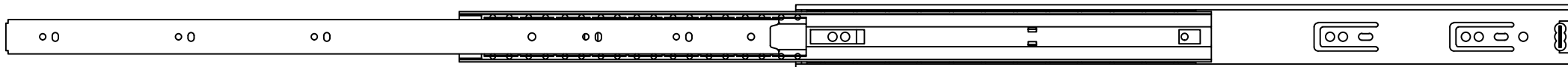

1107,0

557,0



DESIGNED BY F.Dino	CHECKED AND APPROVED BY L. Paleari	REVISION	DATE 07/03/2016	CODE 46550
		GENERAL TOLLERANCE SS-ISO-2768-1M	UNIT mm	SCALE SHEET 2 of 2
		DESCRIPTION	MATERIAL Cold rolled steel	
DEVICE	PAIR WEIGHT 1,696 Kg		03T	

Property of RAM Industrie.  
Without its written authorization the present drawing shall neither be used for construction anyway, communicated to third parties, nor reproduced.