

SEZ. A-A

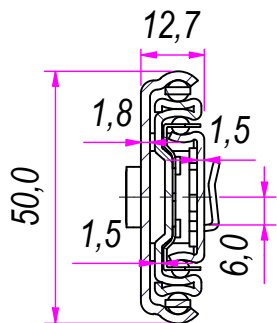

B (1:1)

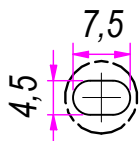

C (1:1.5)

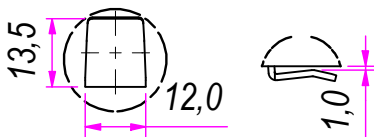

REVISION HISTORY			
REV	DESCRIPTION	APPROVED BY	DATE
1		F.Dino	11/11/2016

DESIGNED BY F.Dino	CHECKED AND APPROVED BY L. Paleari	REVISION	DATE 11/11/2016	CODE 52650
GENERAL TOLLERANCE SS-ISO-2768-1M			UNIT mm	SCALE 1 of 2
DESCRIPTION Bayonet side mounting			MATERIAL Cold rolled steel	
DEVICE			PAIR WEIGHT 2,722 Kg	02C

**RAM**  
INDUSTRIE

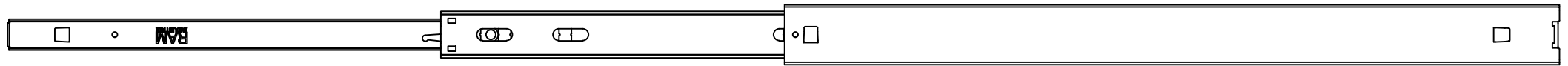

1302,0

652,0

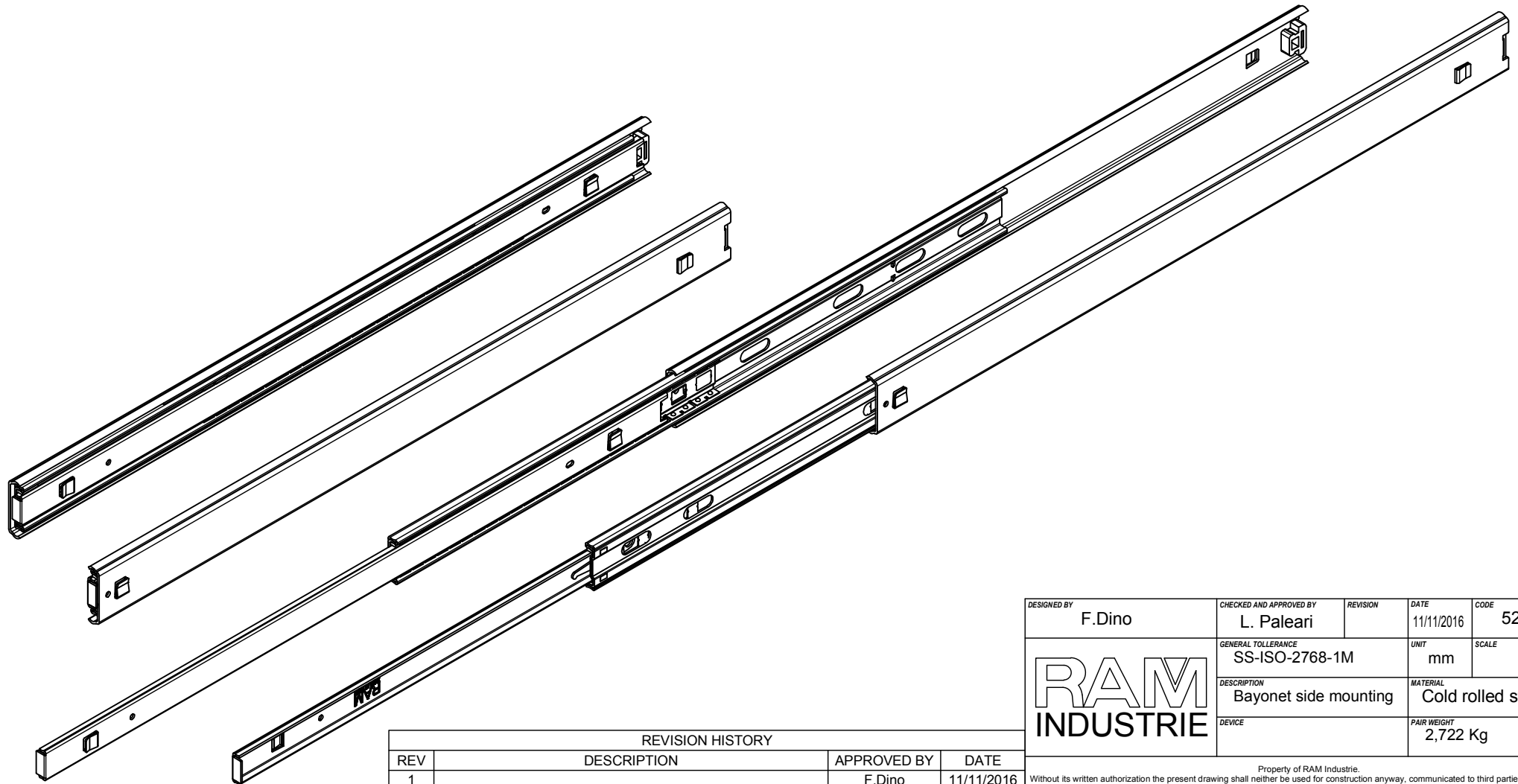
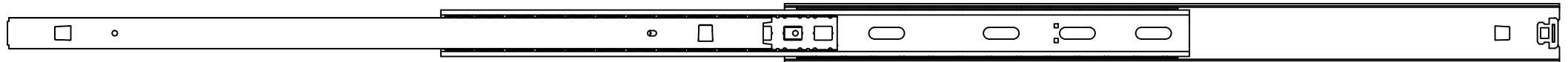
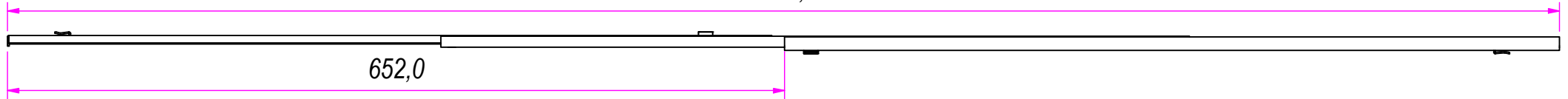

REVISION HISTORY			
REV	DESCRIPTION	APPROVED BY	DATE
1		F.Dino	11/11/2016

DESIGNED BY F.Dino	CHECKED AND APPROVED BY L. Paleari	REVISION	DATE 11/11/2016	CODE 52650
		GENERAL TOLLERANCE SS-ISO-2768-1M	UNIT mm	SCALE SHEET 2 of 2
		DESCRIPTION Bayonet side mounting	MATERIAL Cold rolled steel	PAIR WEIGHT 2,722 Kg

Property of RAM Industrie.  
Without its written authorization the present drawing shall neither be used for construction anyway, communicated to third parties, nor reproduced.