

600,0

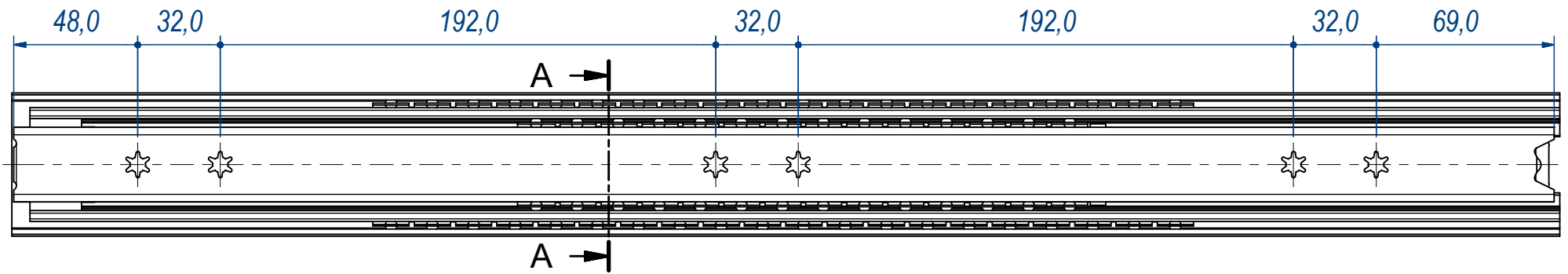

SEZ. A-A

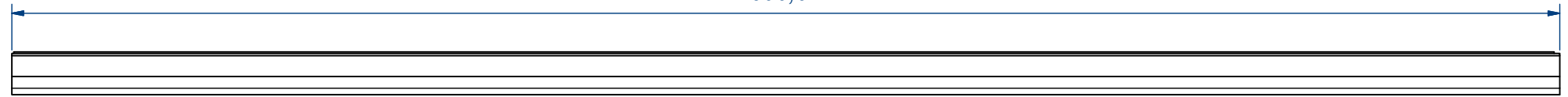
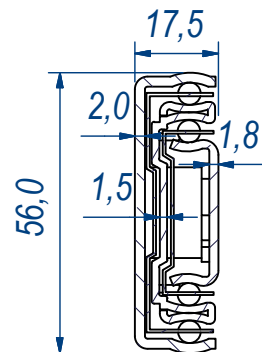
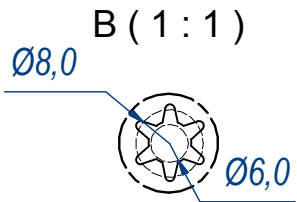

DESIGNED BY F.Dino	CHECKED AND APPROVED BY L. Paleari	REVISION	DATE 20/04/2016	CODE 56600
GENERAL TOLLERANCE SS-ISO-2768-1M			UNIT mm	SCALE 1 of 2
			MATERIAL Cold rolled steel	
			PAIR WEIGHT 3,486 Kg	01T

Property of RAM Industrie.
Without its written authorization the present drawing shall neither be used for construction anyway, communicated to third parties, nor reproduced.

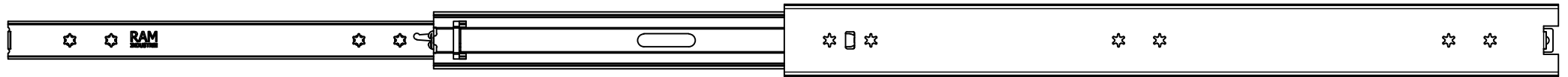

603,0

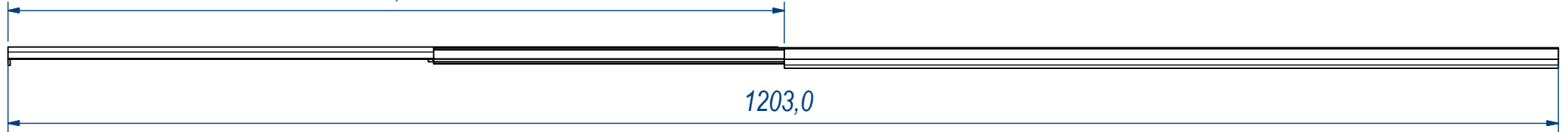

1203,0

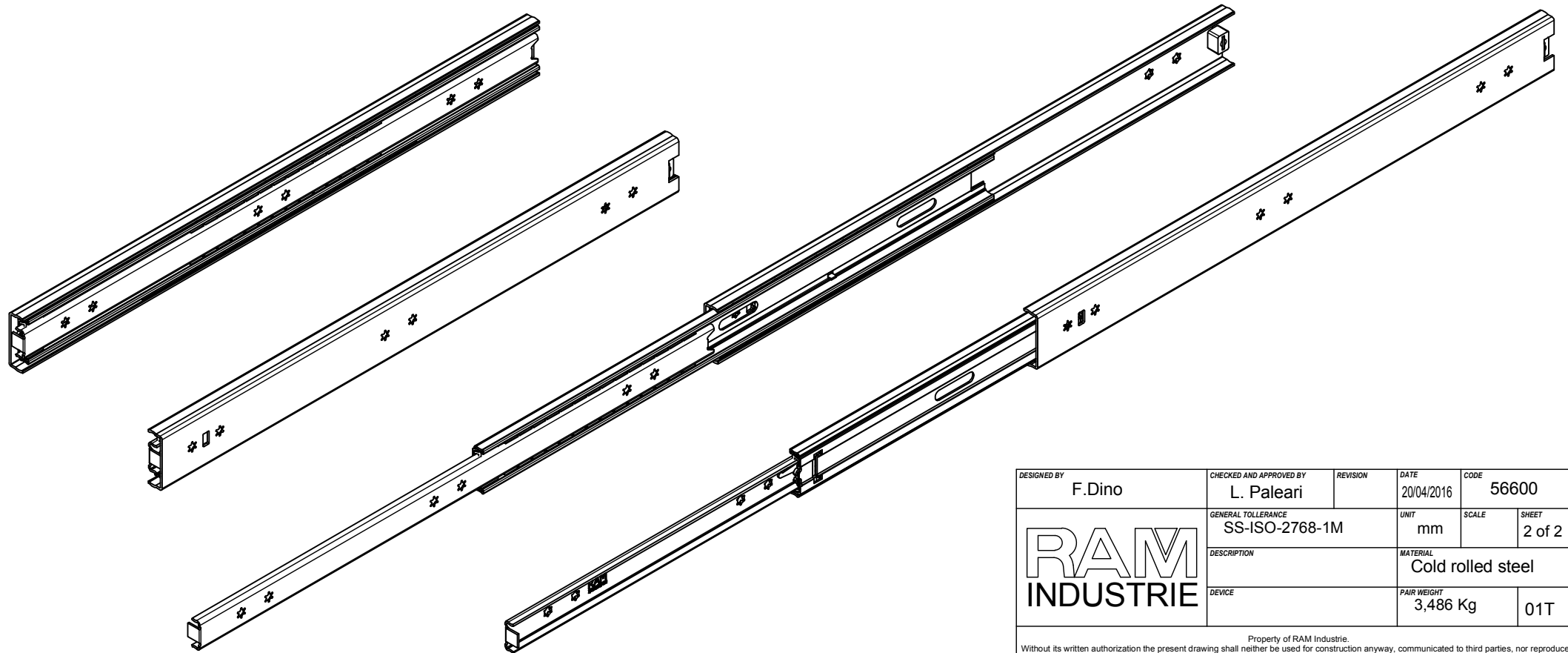
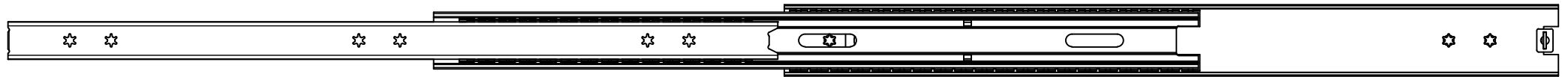

DESIGNED BY F.Dino	CHECKED AND APPROVED BY L. Paleari	REVISION	DATE 20/04/2016	CODE 56600
GENERAL TOLLERANCE SS-ISO-2768-1M		UNIT mm	SCALE	SHEET 2 of 2
DESCRIPTION			MATERIAL Cold rolled steel	
DEVICE			PAIR WEIGHT 3,486 Kg	01T

RAM
INDUSTRIE

Property of RAM Industrie.
Without its written authorization the present drawing shall neither be used for construction anyway, communicated to third parties, nor reproduced.