

B (1:1)

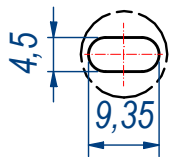

C (1:1)

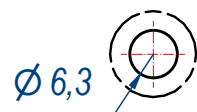

D (1:1)

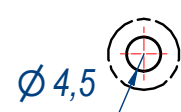

E (1:1)

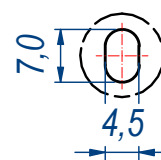

DESIGNED BY F.Dino	CHECKED AND APPROVED BY L. Paleari	REVISION	DATE 26/01/2016	CODE 62200
		GENERAL TOLLERANCE SS-ISO-2768-1M	UNIT mm	SCALE 1 of 2
		DESCRIPTION DEVICE Self closing	MATERIAL Zinc coated steel	PAIR WEIGHT 0,426 Kg
SHEET 02T				

Property of RAM Industrie.
Without its written authorization the present drawing shall neither be used for construction anyway, communicated to third parties, nor reproduced.

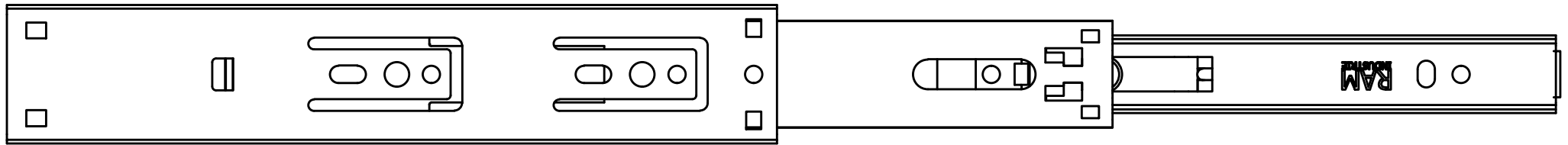

403,0

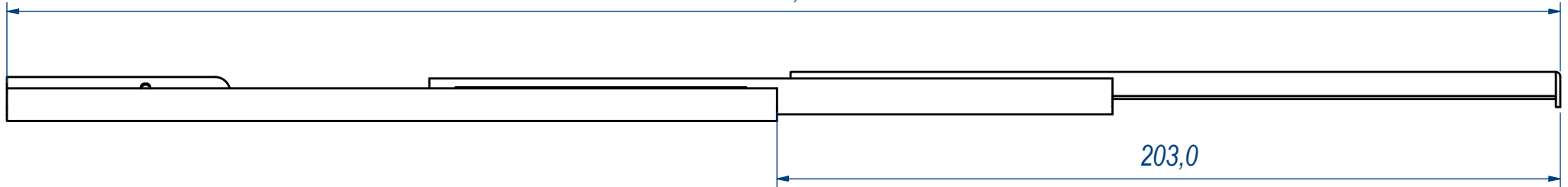

203,0

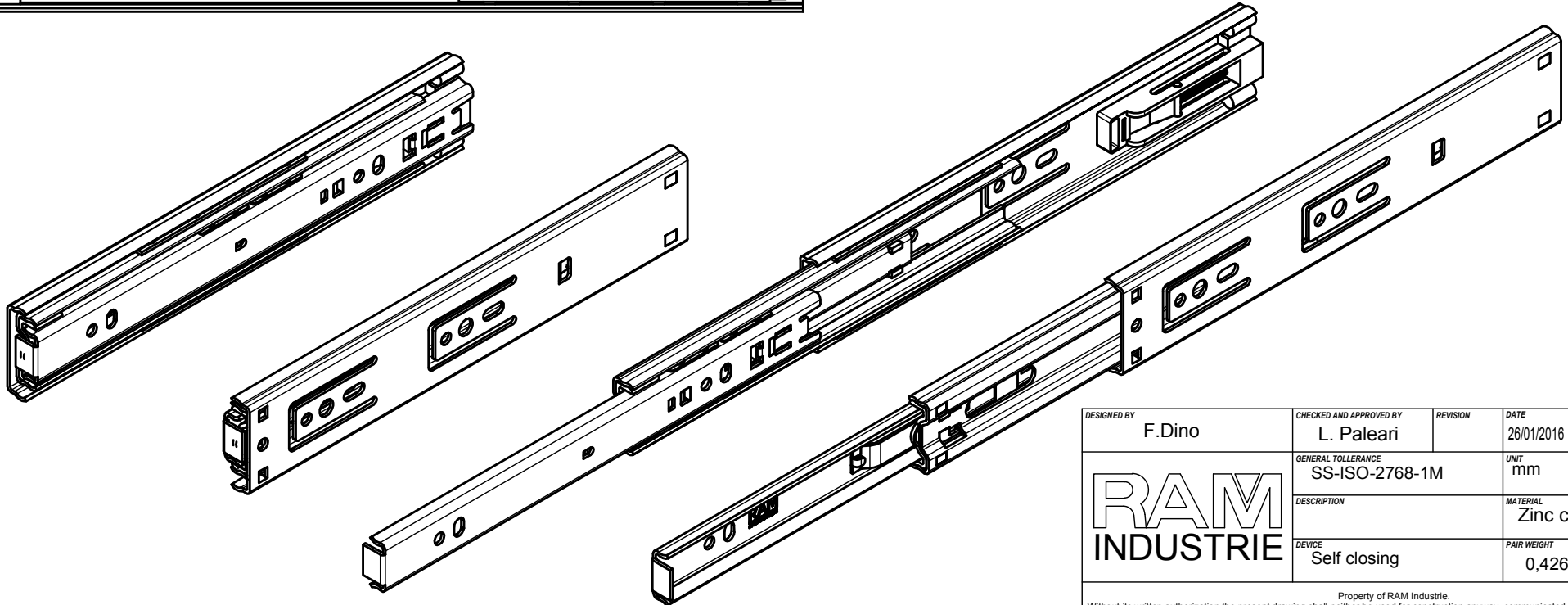
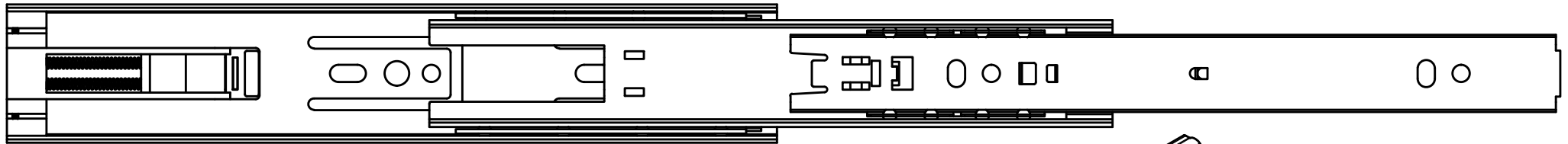

DESIGNED BY F.Dino	CHECKED AND APPROVED BY L. Paleari	REVISION	DATE 26/01/2016	CODE 62200
GENERAL TOLLERANCE SS-ISO-2768-1M		UNIT mm	SCALE	SHEET 2 of 2
DESCRIPTION Self closing		MATERIAL Zinc coated steel		
PAIR WEIGHT 0,426 Kg		02T		

Property of RAM Industrie.
Without its written authorization the present drawing shall neither be used for construction anyway, communicated to third parties, nor reproduced.