

B (1:1)

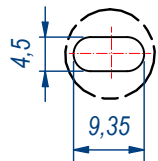

C (1:1)

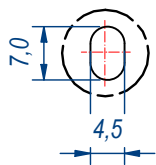

DESIGNED BY F.Dino	CHECKED AND APPROVED BY L. Paleari	REVISION	DATE 26/01/2016	CODE 62500
		GENERAL TOLLERANCE SS-ISO-2768-1M	UNIT mm	SCALE 1 of 2
		DESCRIPTION	MATERIAL Zinc coated steel	
DEVICE Self closing		PAIR WEIGHT 1,13 Kg	02T	

Property of RAM Industrie.  
Without its written authorization the present drawing shall neither be used for construction anyway, communicated to third parties, nor reproduced.

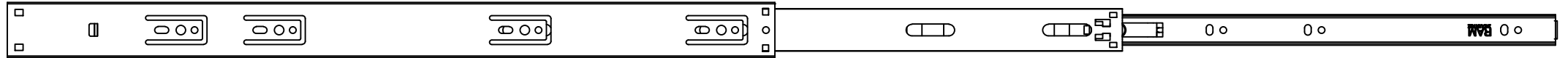

1010,0

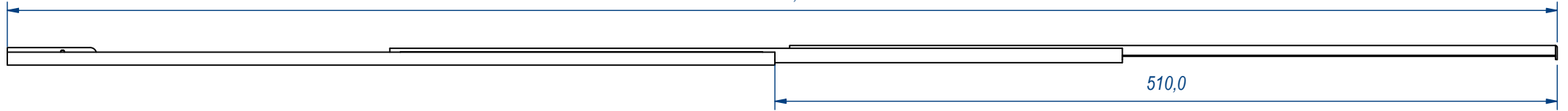

510,0

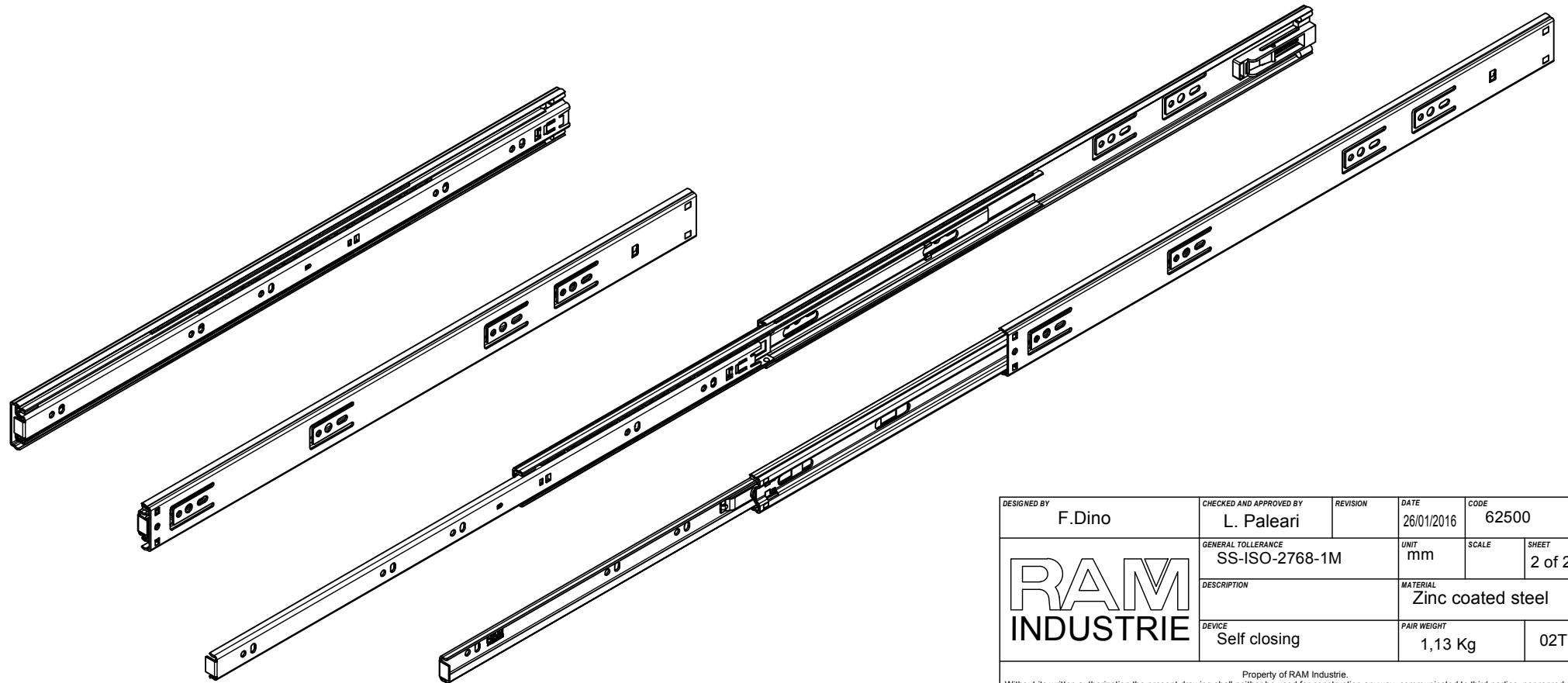
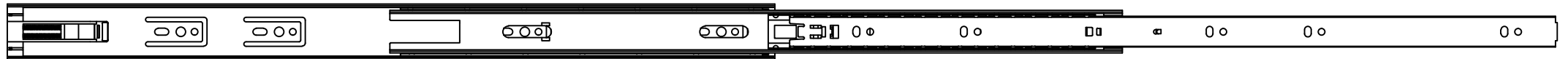

DESIGNED BY F.Dino	CHECKED AND APPROVED BY L. Paleari	REVISION	DATE 26/01/2016	CODE 62500
		GENERAL TOLLERANCE SS-ISO-2768-1M	UNIT mm	SCALE SHEET 2 of 2
		DESCRIPTION DEVICE Self closing	MATERIAL Zinc coated steel	PAIR WEIGHT 1,13 Kg

Property of RAM Industrie.  
Without its written authorization the present drawing shall neither be used for construction anyway, communicated to third parties, nor reproduced.