

B (1 : 0.5)

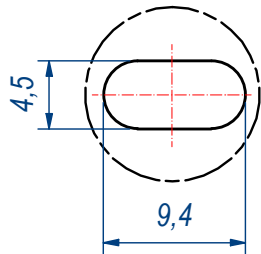

E (1 : 0.5)

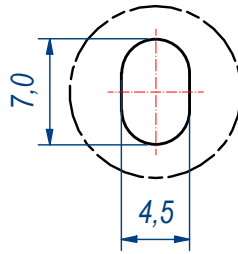

SEZ. A-A

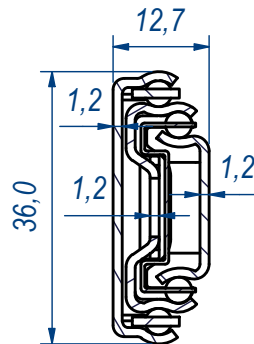

DESIGNED BY F.Dino	CHECKED AND APPROVED BY L. Paleari	REVISION	DATE 26/01/2016	CODE 62550
GENERAL TOLLERANCE SS-ISO-2768-1M		UNIT mm	SCALE	SHEET 1 of 2
DESCRIPTION Self closing		MATERIAL Zinc coated steel		
PAIR WEIGHT 1,25 Kg		02T		

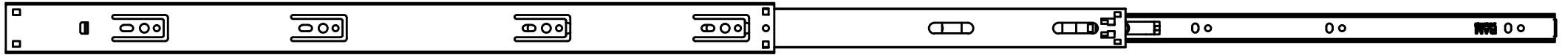

1110,0

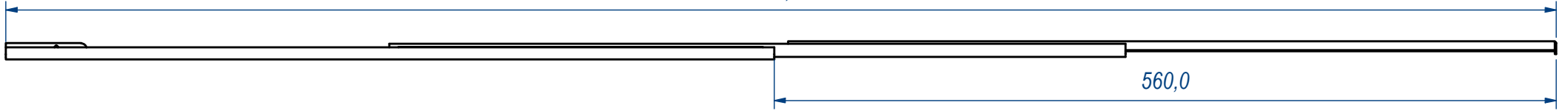

560,0

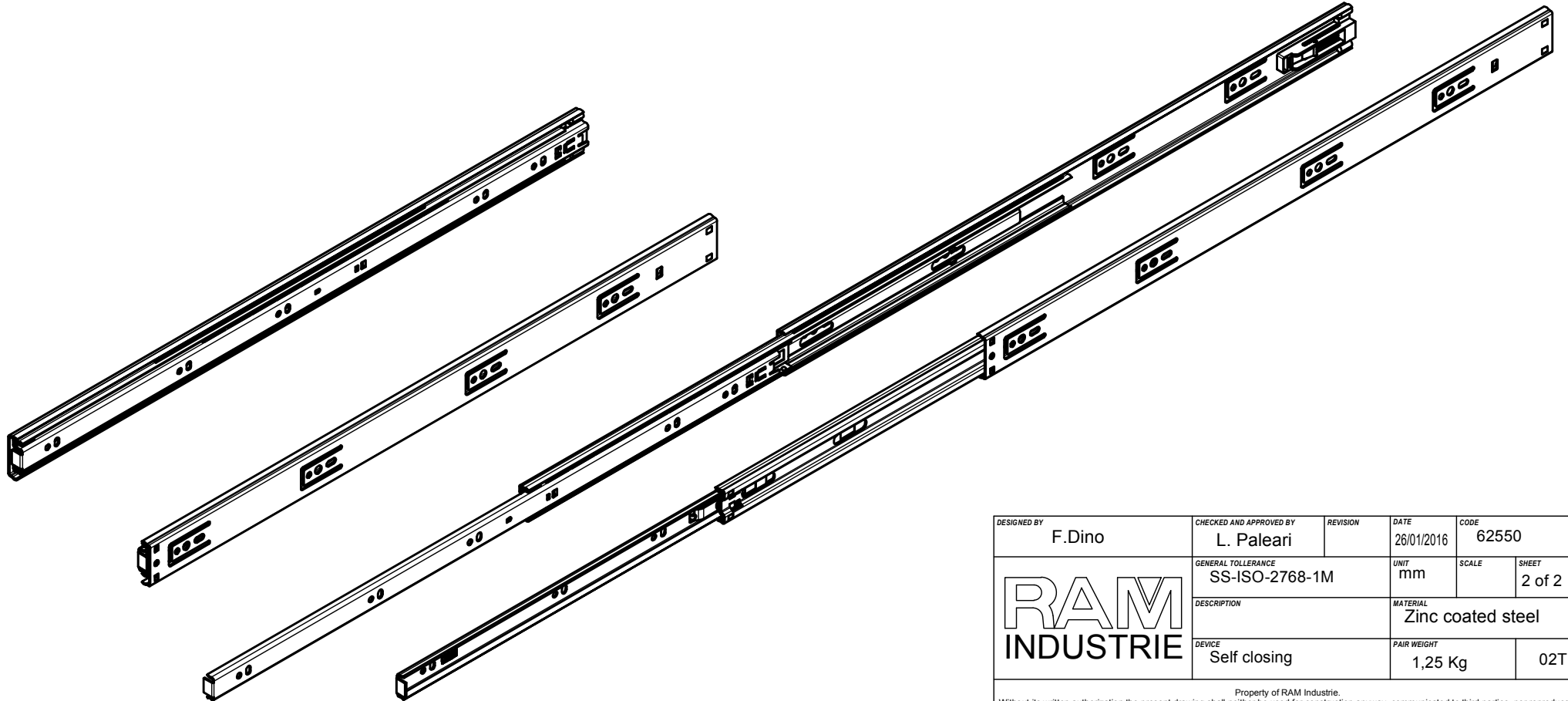

DESIGNED BY F.Dino	CHECKED AND APPROVED BY L. Paleari	REVISION	DATE 26/01/2016	CODE 62550
		GENERAL TOLLERANCE SS-ISO-2768-1M	UNIT mm	SCALE 2 of 2
		DESCRIPTION Self closing	MATERIAL Zinc coated steel	PAIR WEIGHT 1,25 Kg
SHEET 02T				

Property of RAM Industrie.  
Without its written authorization the present drawing shall neither be used for construction anyway, communicated to third parties, nor reproduced.