

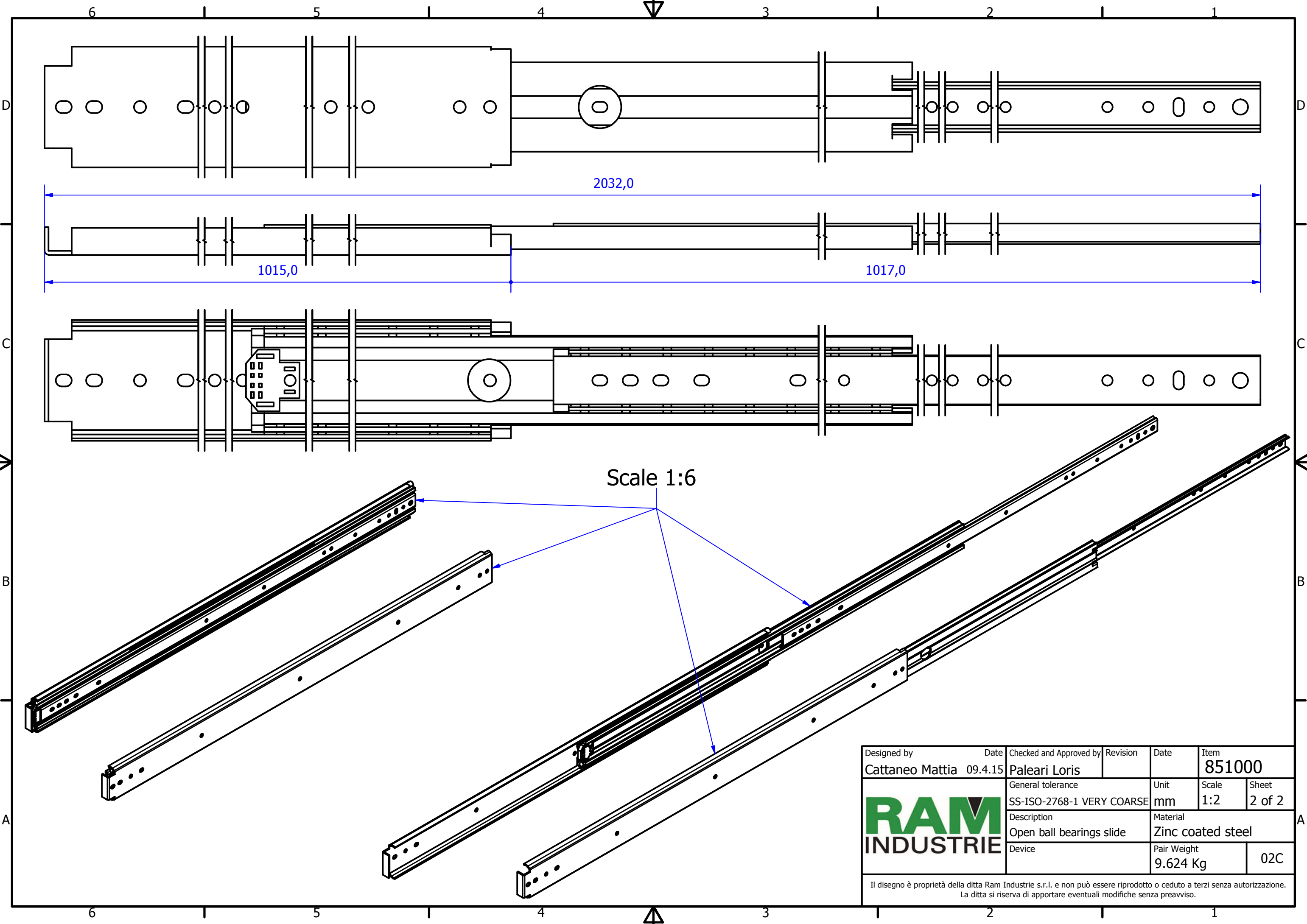

Designed by Cattaneo Mattia	Date 09.4.15	Checked and Approved by Paleari Loris	Revision	Date	Item 851000
		General tolerance SS-ISO-2768-1 MEDIUM	Unit mm	Scale 1:1.5	Sheet 1 of 2
		Description Closed ball bearings slide	Material Zinc coated steel		
Device		Pair Weight 9.624 Kg	02C		
Il disegno è proprietà della ditta Ram Industrie s.r.l. e non può essere riprodotto o ceduto a terzi senza autorizzazione. La ditta si riserva di apportare eventuali modifiche senza preavviso.					



Scale 1:6

Designed by Cattaneo Mattia	Date 09.4.15	Checked and Approved by Paleari Loris	Revision	Date	Item 851000
		General tolerance SS-ISO-2768-1 VERY COARSE	Unit mm	Scale 1:2	Sheet 2 of 2
		Description Open ball bearings slide	Material Zinc coated steel		
		Device	Pair Weight 9.624 Kg	02C	
		Il disegno è proprietà della ditta Ram Industrie s.r.l. e non può essere riprodotto o ceduto a terzi senza autorizzazione. La ditta si riserva di apportare eventuali modifiche senza preavviso.			