

SEZ. A-A

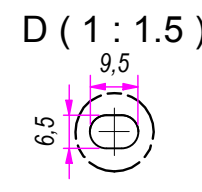

REVISION HISTORY			
REV	DESCRIPTION	APPROVED BY	DATE
1		F.Dino	06/07/2020

DESIGNED BY F.Dino	CHECKED AND APPROVED BY L. Paleari	DATE 06/07/2020	CODE 881200
		GENERAL TOLLERANCE SS-ISO-2768-1M	UNIT mm
		DESCRIPTION	MATERIAL Cold rolled steel
DEVICE		PIECE WEIGHT 16,2 Kg	SHEET 1 of 3
<small>Property of RAM Industrie. Without its written authorization the present drawing shall neither be used for construction anyway, communicated to third parties, nor reproduced.</small>			

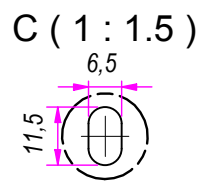
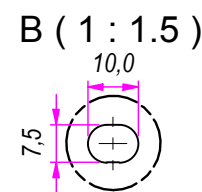
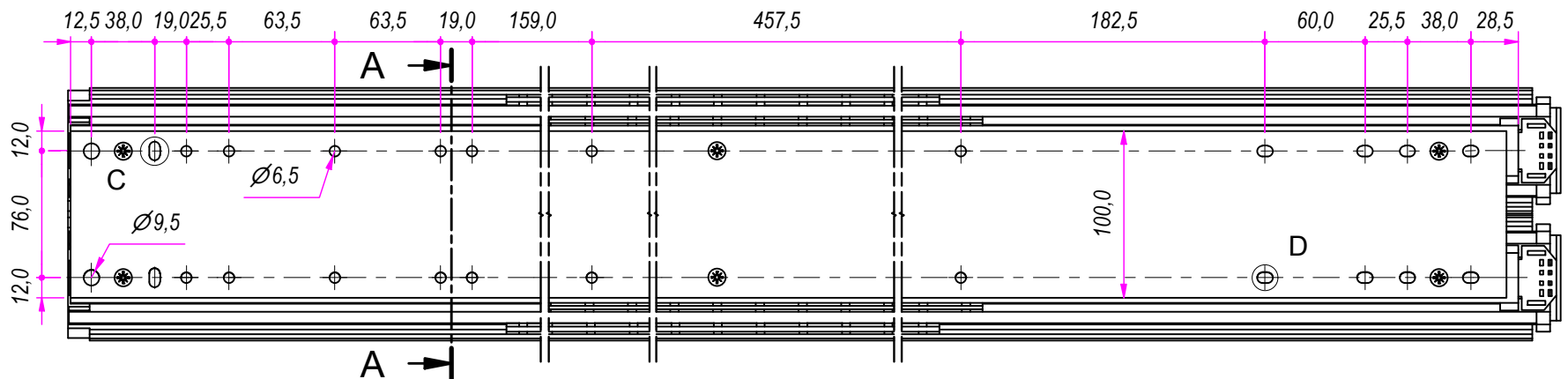
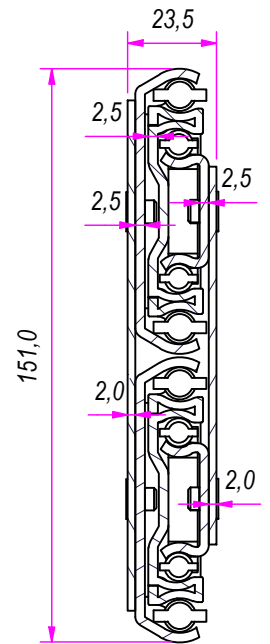
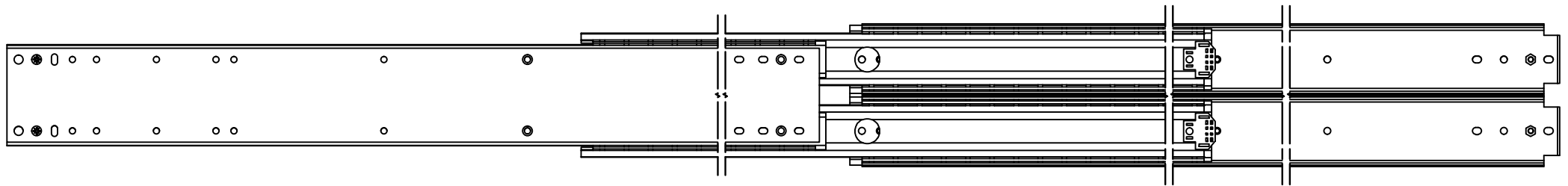
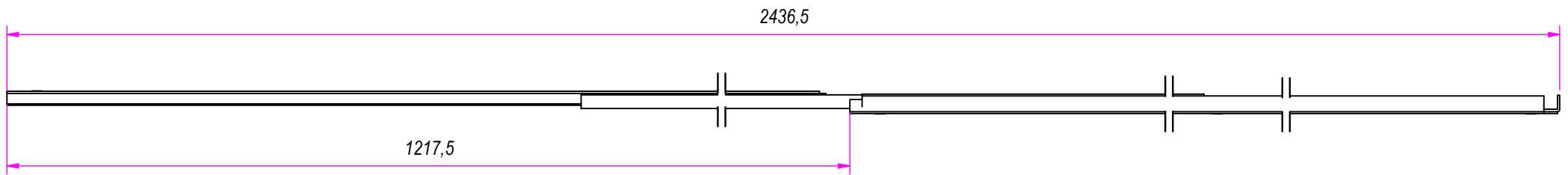
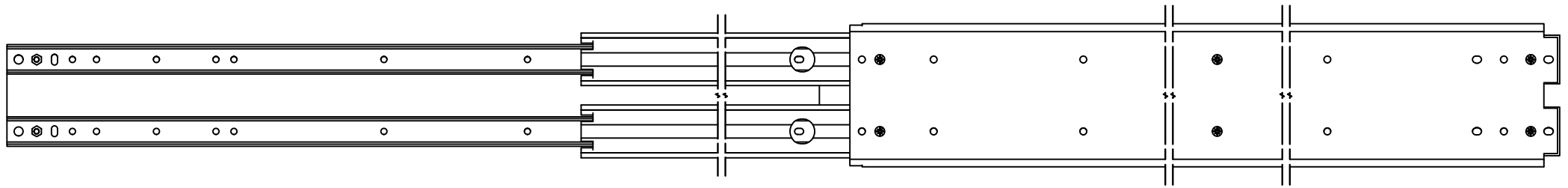

REVISION HISTORY			
REV	DESCRIPTION	APPROVED BY	DATE
1		F.Dino	06/07/2020

DESIGNED BY F.Dino	CHECKED AND APPROVED BY L. Paleari	DATE 06/07/2020	CODE 881200
	GENERAL TOLLERANCE SS-ISO-2768-1M	UNIT mm	SCALE SHEET 2 of 3
	DESCRIPTION	MATERIAL Cold rolled steel	
	DEVICE	PIECE WEIGHT 16,2 Kg	

Property of RAM Industrie.
Without its written authorization the present drawing shall neither be used for construction anyway, communicated to third parties, nor reproduced.

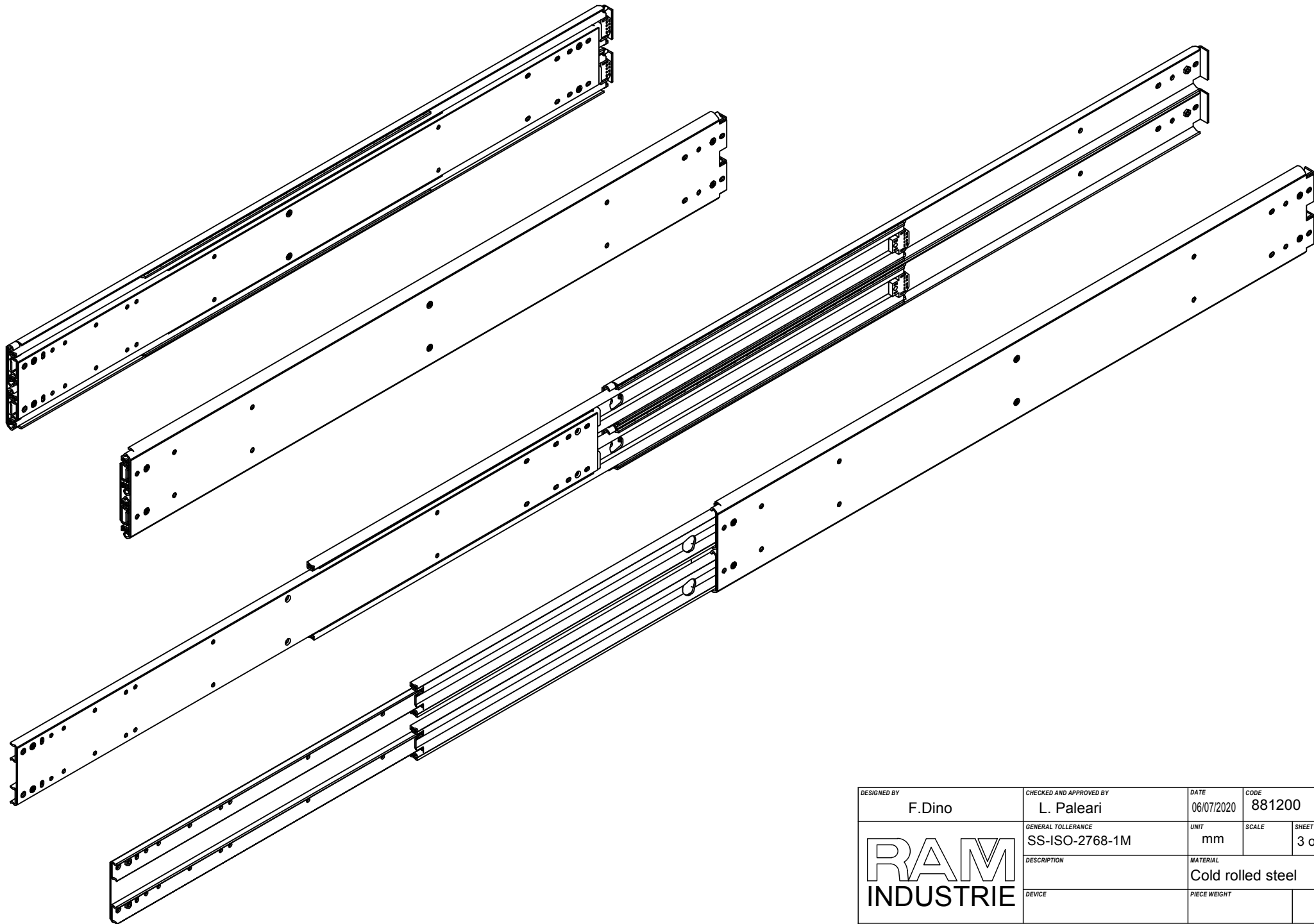

DESIGNED BY F.Dino	CHECKED AND APPROVED BY L. Paleari	DATE 06/07/2020	CODE 881200	
	GENERAL TOLLERANCE SS-ISO-2768-1M	UNIT mm	SCALE	SHEET 3 of 3
	DESCRIPTION	MATERIAL Cold rolled steel		
	DEVICE	PIECE WEIGHT		

Property of RAM Industrie.
Without its written authorization the present drawing shall neither be used for construction anyway, communicated to third parties, nor reproduced.