

B (1 : 1.5)

C (1 : 1.5)

D (1 : 1.5)

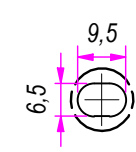
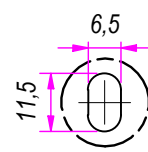
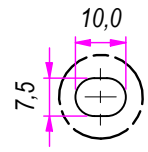

Guide per cassetti; guide telescopiche	Coulisses à billes; coulisse télescopique	
Drawer slide; telescopic ball bearing slide	Guías para cajones; guía teleópica	REV
Kugelführung; Teleskopschienen		1a

REVISION HISTORY	
DESCRIPTION	DATE
	06/07/2020

DESIGNED BY F. Dino	CHECKED AND APPROVED BY L. Paleari	GENERAL TOLERANCE SS-ISO-2768-1M	DATE 06/07/2020	CODE 881300
PACKAGING			UNIT mm	SHEET 1 of 3
DESCRIPTION			MATERIAL Cold rolled steel	
DEVICE			PAIR WEIGHT	
Property of RAM Industrie. Without its written authorization the present drawing shall neither be used for construction anyway, communicated to third parties, nor reproduced.				



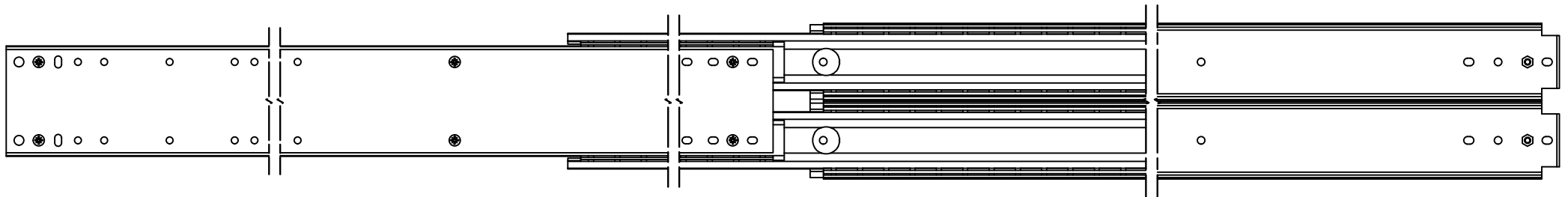
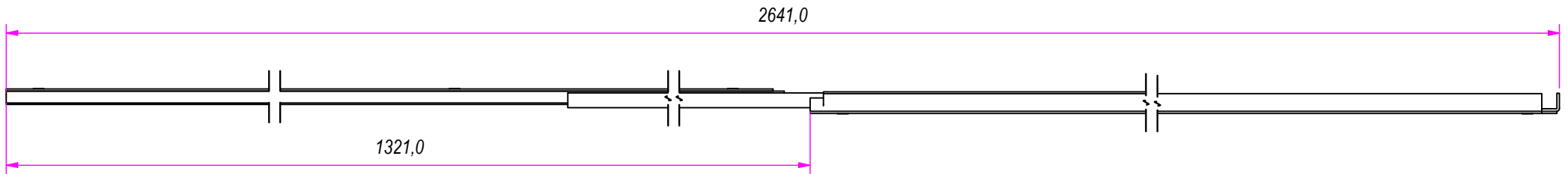
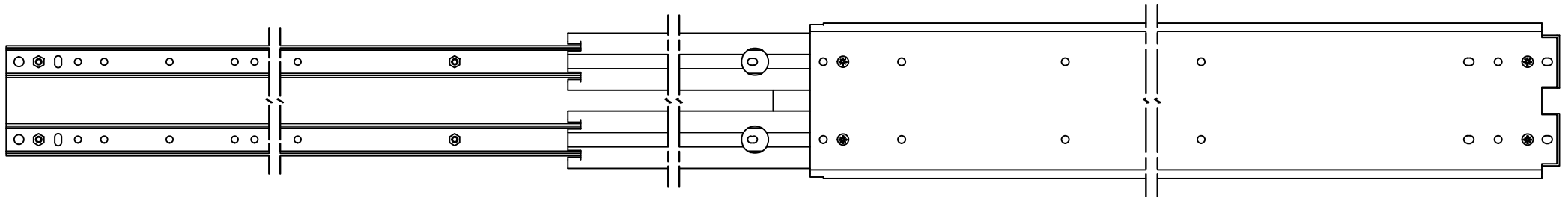



DESIGNED BY F.Dino	CHECKED AND APPROVED BY L. Paleari	GENERAL TOLLERANCE SS-ISO-2768-1M	DATE 06/07/2020	CODE 881300
PACKAGING			UNIT mm	SHEET 2 of 3
DESCRIPTION			MATERIAL Cold rolled steel	
DEVICE			PAIR WEIGHT	

RAM
INDUSTRIE

		REVISION HISTORY		
		REV	DESCRIPTION	DATE
Guida per cassetti; guide telescopiche	Coulisses à billes; coulisse télescopique			
Drawer slide; telescopic ball bearing slide	Guías para cajones; guía teleópica	1a		06/07/2020
Kugelführung; Teleskopschienen				

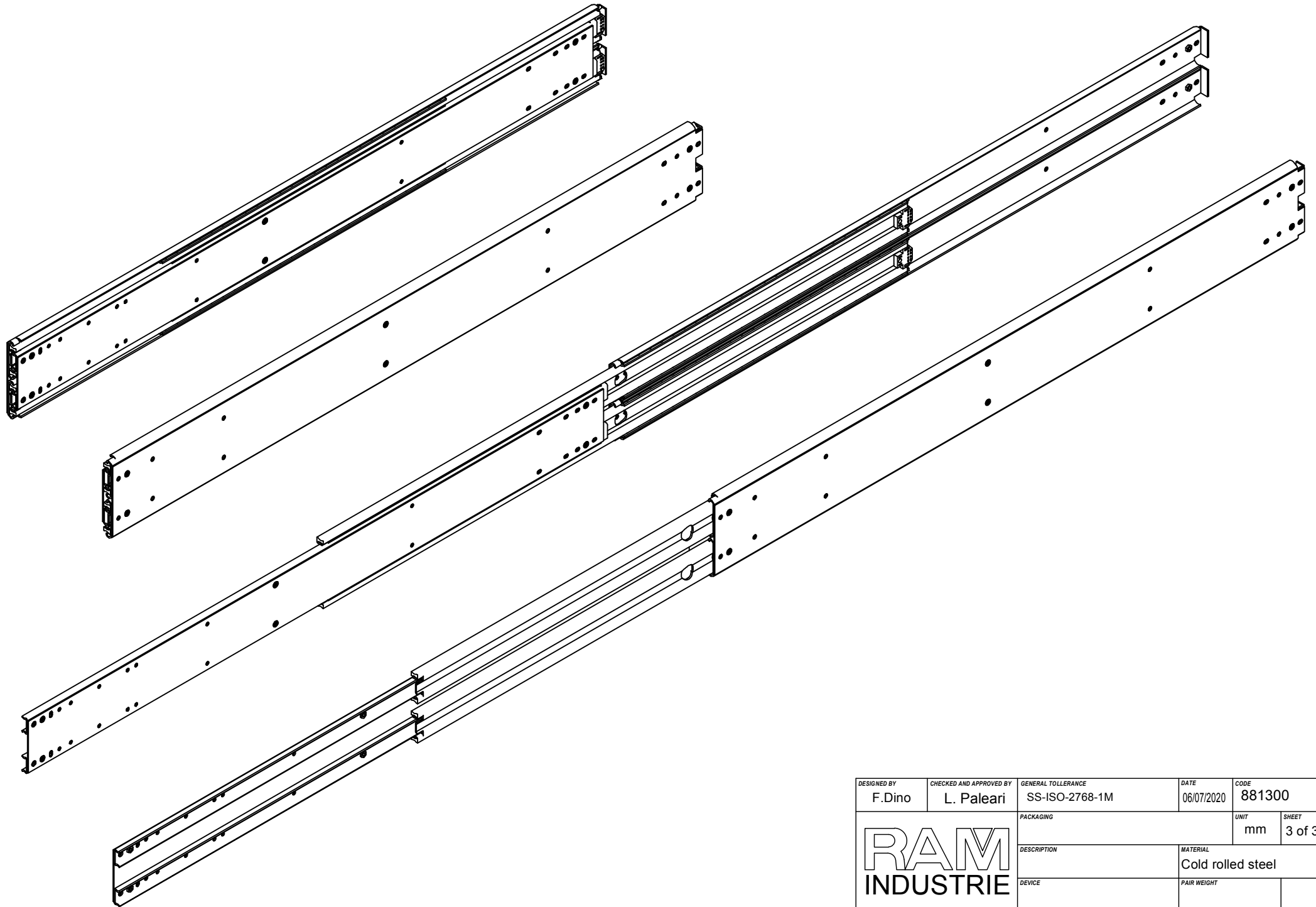
Property of RAM Industrie.
Without its written authorization the present drawing shall neither be used for construction anyway, communicated to third parties, nor reproduced.



DESIGNED BY F.Dino	CHECKED AND APPROVED BY L. Paleari	GENERAL TOLERANCE SS-ISO-2768-1M	DATE 06/07/2020	CODE 881300	
			PACKAGING	UNIT mm	SHEET 3 of 3
			DESCRIPTION	MATERIAL Cold rolled steel	
DEVICE			PAIR WEIGHT		

Property of RAM Industrie.
Without its written authorization the present drawing shall neither be used for construction anyway, communicated to third parties, nor reproduced.