

SEZ. A-A

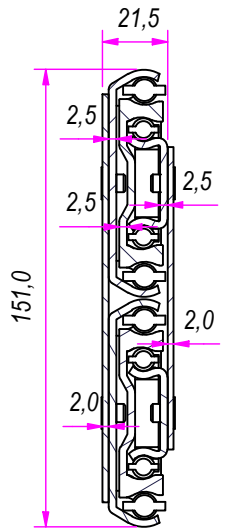

B (1:1.5) C (1:1.5) D (1:1.5)

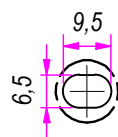
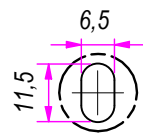
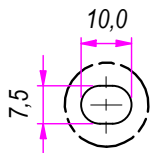

DESIGNED BY F. Dino	CHECKED AND APPROVED BY L. Paleari	GENERAL TOLERANCE SS-ISO-2768-1M	DATE 06/07/2020	CODE 881500
PACKAGING			UNIT mm	SHEET 1 of 3
DESCRIPTION			MATERIAL Cold rolled steel	
DEVICE			PAIR WEIGHT 20,4 Kg	

RAM
INDUSTRIE

DESCRIPTION	REVISION HISTORY	DATE
Guide per cassetti; guide telescopiche Coulisses à billes; coulisse télescopique Drawer slide; telescopic ball bearing slide Guías para cajones; guía teleópica Kugelführung; Teleskopschienen	REV 1a	06/07/2020

Property of RAM Industrie.
Without its written authorization the present drawing shall neither be used for construction anyway, communicated to third parties, nor reproduced.

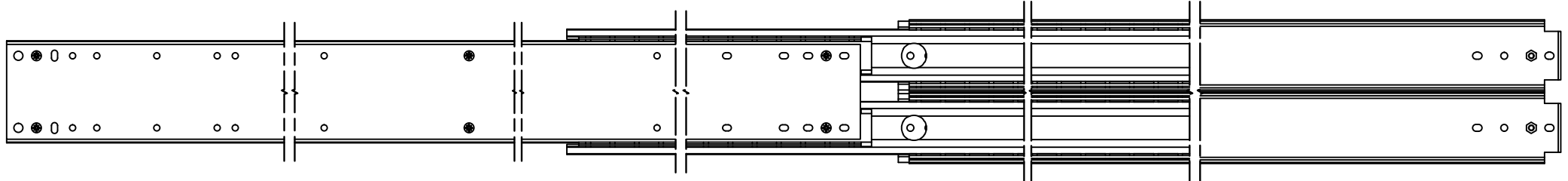
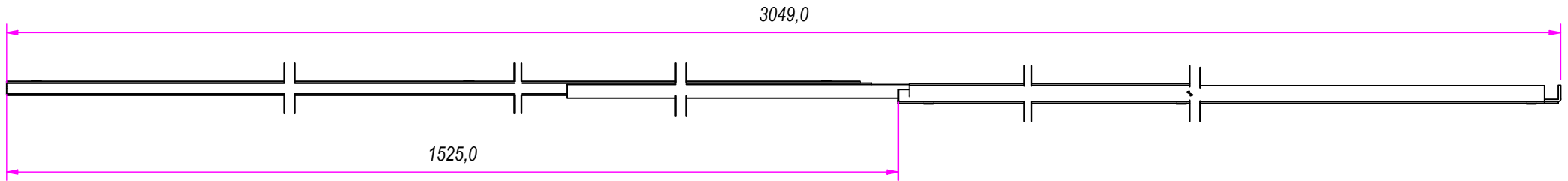
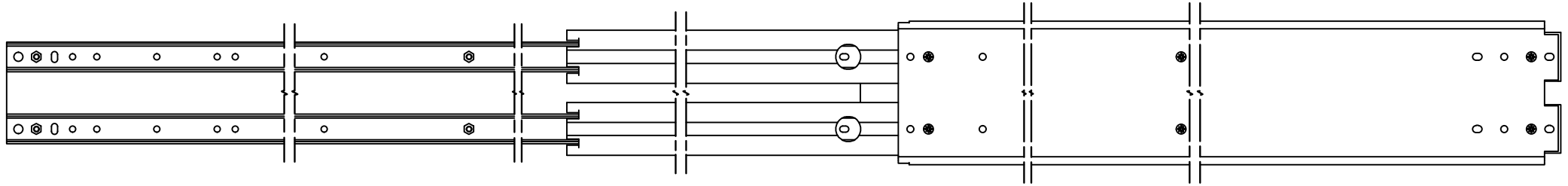

Guida per cassetti; guide telescopiche	Coulisses à billes; coulisse télescopique
Drawer slide; telescopic ball bearing slide	Guías para cajones; guía teleópica
Kugelführung; Teleskopschienen	

REVISION HISTORY	
REV	DESCRIPTION
1a	

DESIGNED BY F.Dino	CHECKED AND APPROVED BY L. Paleari	GENERAL TOLERANCE SS-ISO-2768-1M	DATE 06/07/2020	CODE 881500
			PACKAGING	UNIT mm
			DESCRIPTION	MATERIAL Cold rolled steel
			DEVICE	PAIR WEIGHT 20,4 Kg
Property of RAM Industrie. Without its written authorization the present drawing shall neither be used for construction anyway, communicated to third parties, nor reproduced.				

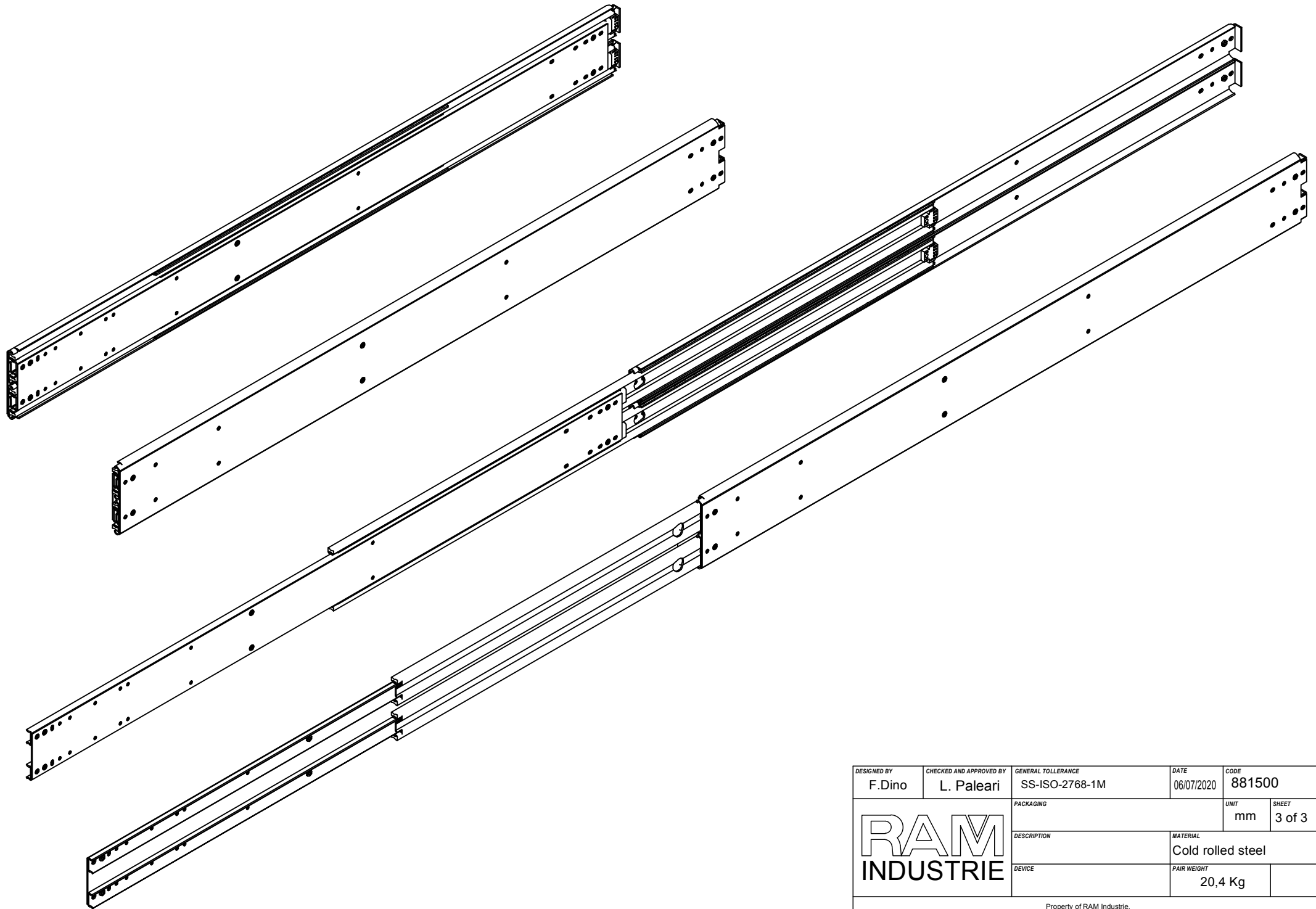

DESIGNED BY F.Dino	CHECKED AND APPROVED BY L. Paleari	GENERAL TOLERANCE SS-ISO-2768-1M	DATE 06/07/2020	CODE 881500	
			PACKAGING	UNIT mm	SHEET 3 of 3
			DESCRIPTION	MATERIAL Cold rolled steel	
DEVICE	PAIR WEIGHT 20,4 Kg				

Property of RAM Industrie.
Without its written authorization the present drawing shall neither be used for construction anyway, communicated to third parties, nor reproduced.