

B ( 1 : 1.5 )

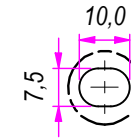

C ( 1 : 1.5 )

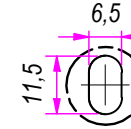

D ( 1 : 1.5 )

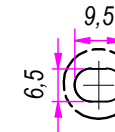

SEZ. A-A

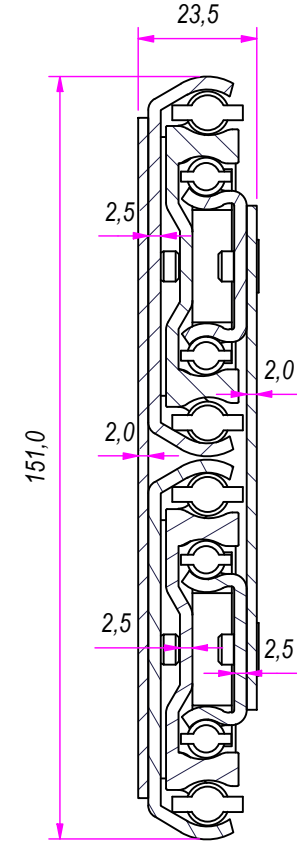

REVISION HISTORY			
REV	DESCRIPTION	APPROVED BY	DATE
1		F.Dino	04/12/2020

DESIGNED BY <b>F.Dino</b>	CHECKED AND APPROVED BY <b>L. Paleari</b>	DATE 04/12/2020	CODE 88300
		GENERAL TOLLERANCE SS-ISO-2768-1M	UNIT mm
		SCALE 1 of 3	SHEET 1 of 3
DESCRIPTION		MATERIAL Cold rolled steel	
DEVICE		PIECE WEIGHT	

Property of RAM Industrie.  
Without its written authorization the present drawing shall neither be used for construction anyway, communicated to third parties, nor reproduced.

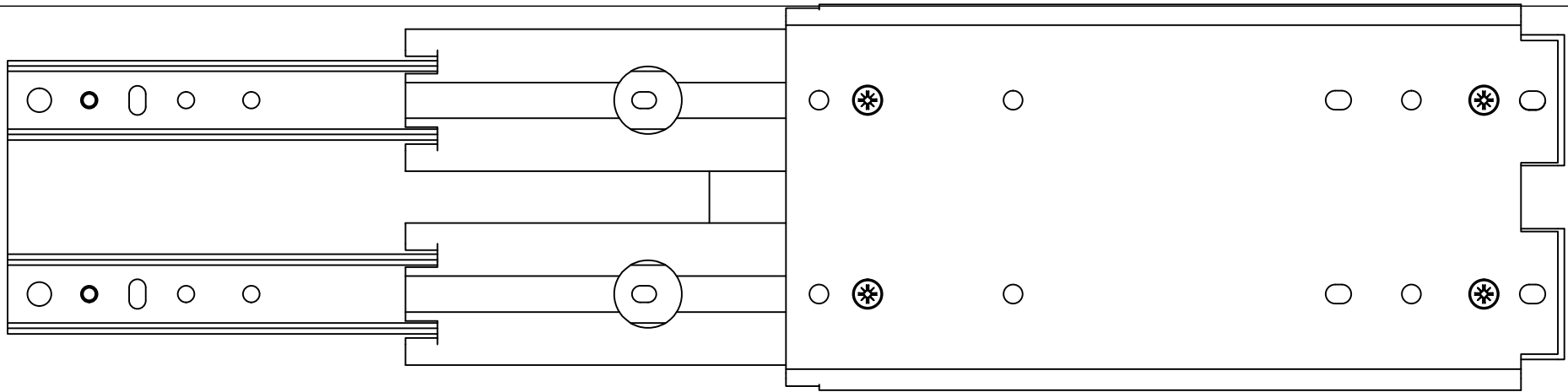

610,0

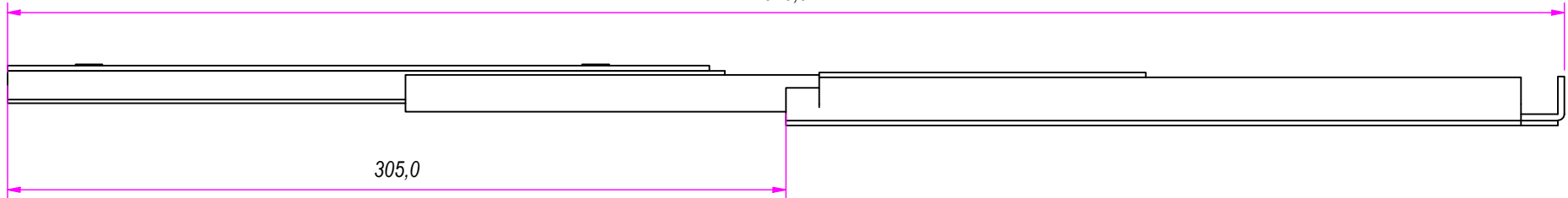

305,0

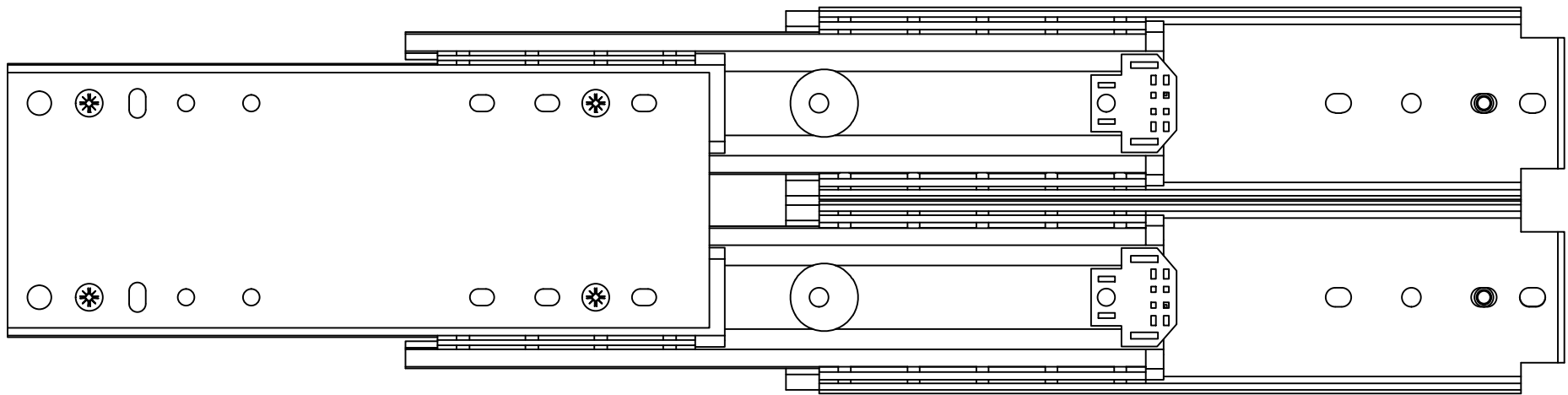

REVISION HISTORY			
REV	DESCRIPTION	APPROVED BY	DATE
1		F.Dino	04/12/2020

DESIGNED BY F.Dino	CHECKED AND APPROVED BY L. Paleari	DATE 04/12/2020	CODE 88300
		GENERAL TOLLERANCE SS-ISO-2768-1M	UNIT mm
		DESCRIPTION	MATERIAL Cold rolled steel
DEVICE		SCALE	SHEET 2 of 3
		PIECE WEIGHT	

Property of RAM Industrie.  
Without its written authorization the present drawing shall neither be used for construction anyway, communicated to third parties, nor reproduced.

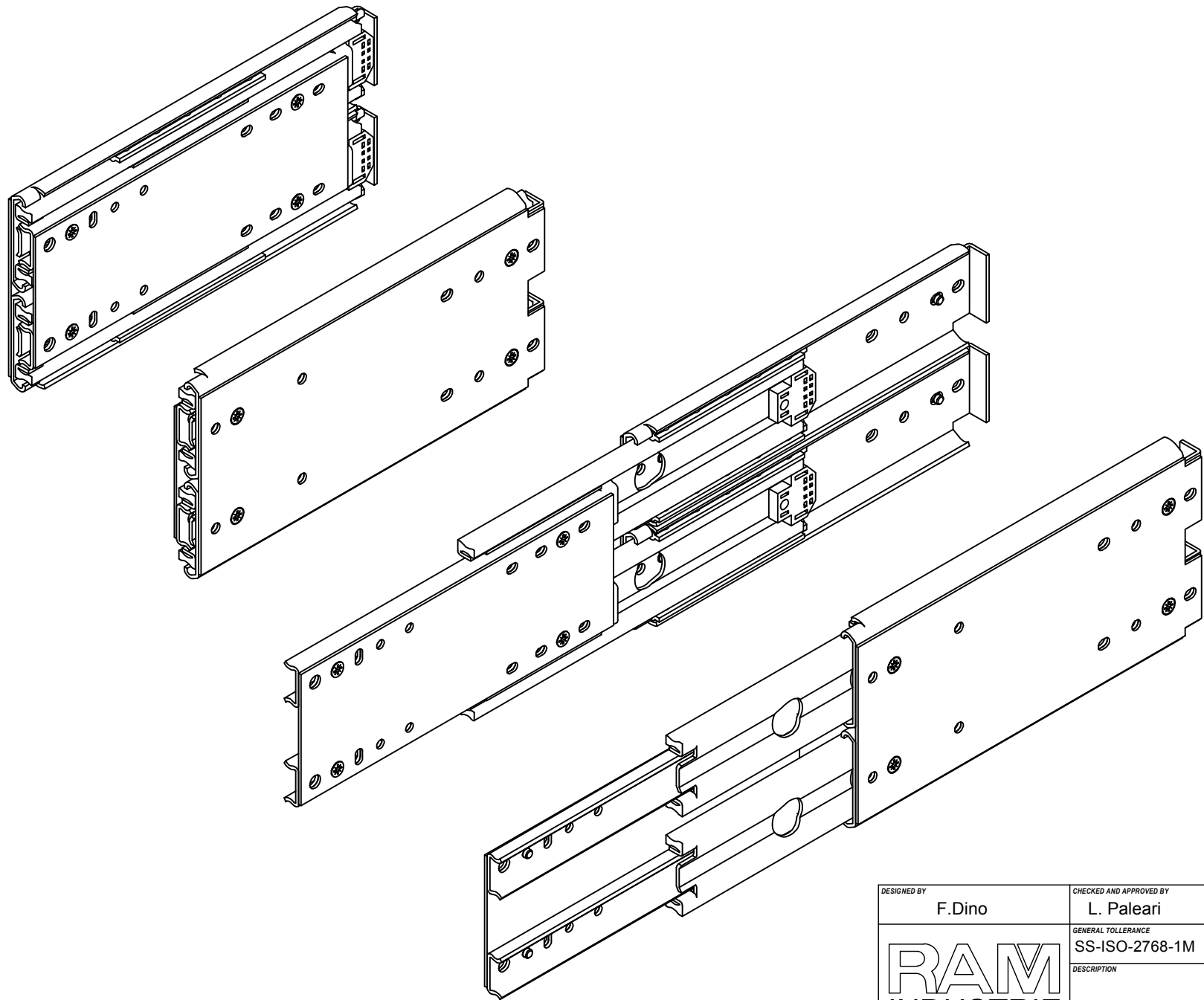

DESIGNED BY F.Dino	CHECKED AND APPROVED BY L. Paleari	DATE 04/12/2020	CODE 88300
	GENERAL TOLLERANCE SS-ISO-2768-1M	UNIT mm	SCALE 3 of 3
	DESCRIPTION	MATERIAL Cold rolled steel	
	DEVICE	PIECE WEIGHT	

Property of RAM Industrie.  
Without its written authorization the present drawing shall neither be used for construction anyway, communicated to third parties, nor reproduced.