

SEZ. A-A

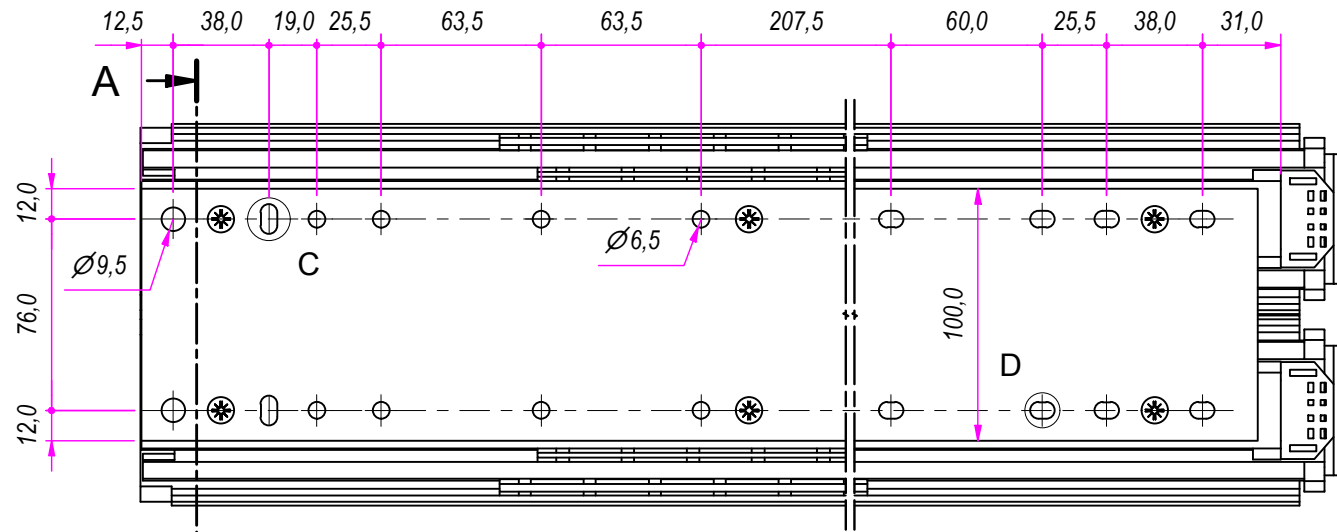
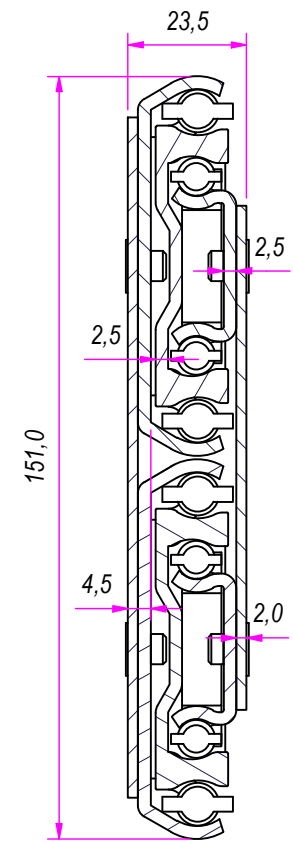

A

B (1 : 1.5)

C (1 : 1.5)

D (1 : 1.5)

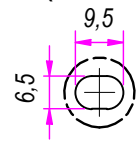
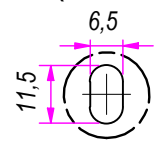
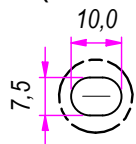

REVISION HISTORY			
REV	DESCRIPTION	APPROVED BY	DATE
1		F.Dino	06/07/2020

DESIGNED BY <b>F.Dino</b>	CHECKED AND APPROVED BY <b>L. Paleari</b>	DATE 06/07/2020	CODE 88600
		GENERAL TOLLERANCE SS-ISO-2768-1M	UNIT mm
		SCALE 1 of 3	SHEET 1 of 3
DESCRIPTION		MATERIAL Cold rolled steel	
DEVICE		PIECE WEIGHT 14,9 Kg	
Property of RAM Industrie. Without its written authorization the present drawing shall neither be used for construction anyway, communicated to third parties, nor reproduced.			

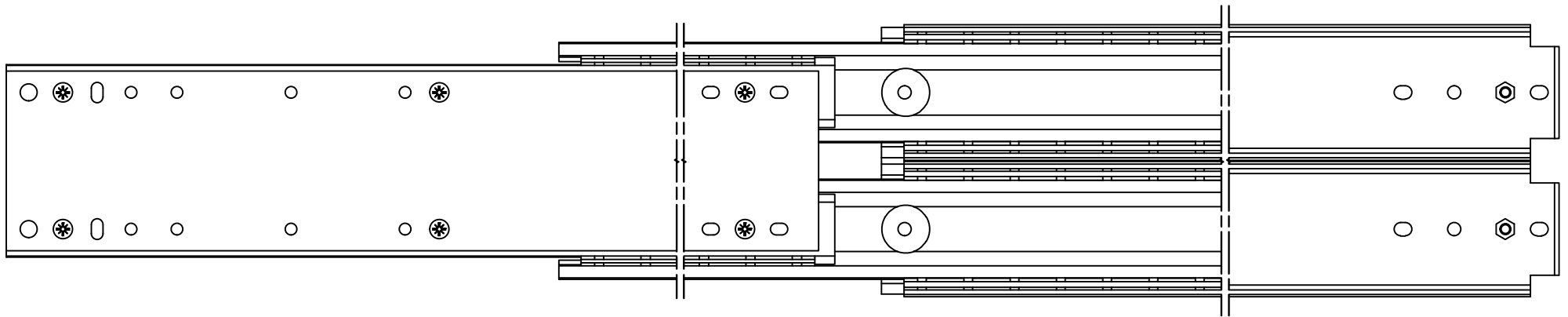
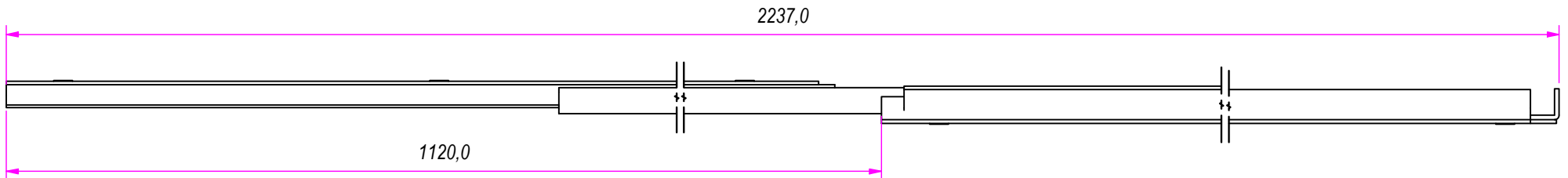
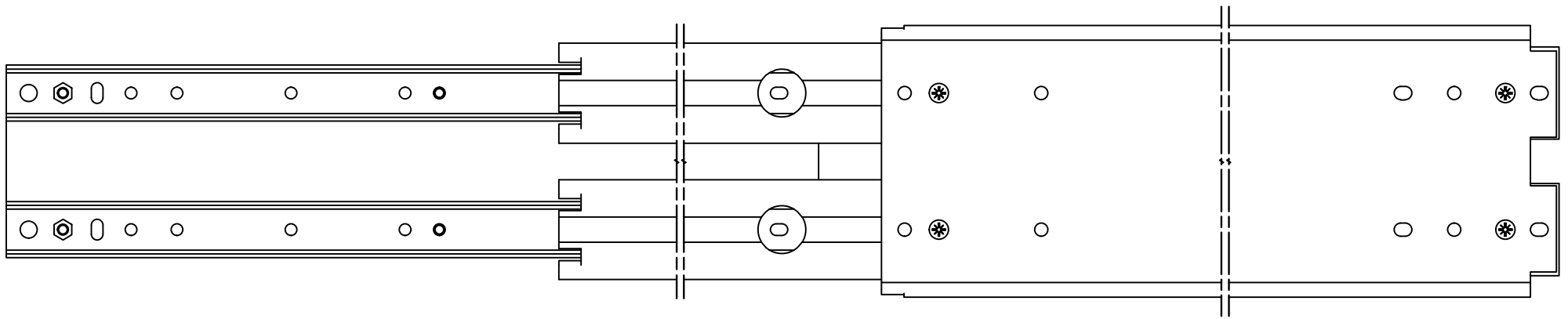

REVISION HISTORY			
REV	DESCRIPTION	APPROVED BY	DATE
1		F.Dino	06/07/2020

DESIGNED BY F.Dino	CHECKED AND APPROVED BY L. Paleari	DATE 06/07/2020	CODE 88600
	GENERAL TOLLERANCE SS-ISO-2768-1M	UNIT mm	SCALE SHEET 2 of 3
	DESCRIPTION	MATERIAL Cold rolled steel	
	DEVICE	PIECE WEIGHT 14,9 Kg	

Property of RAM Industrie.  
Without its written authorization the present drawing shall neither be used for construction anyway, communicated to third parties, nor reproduced.

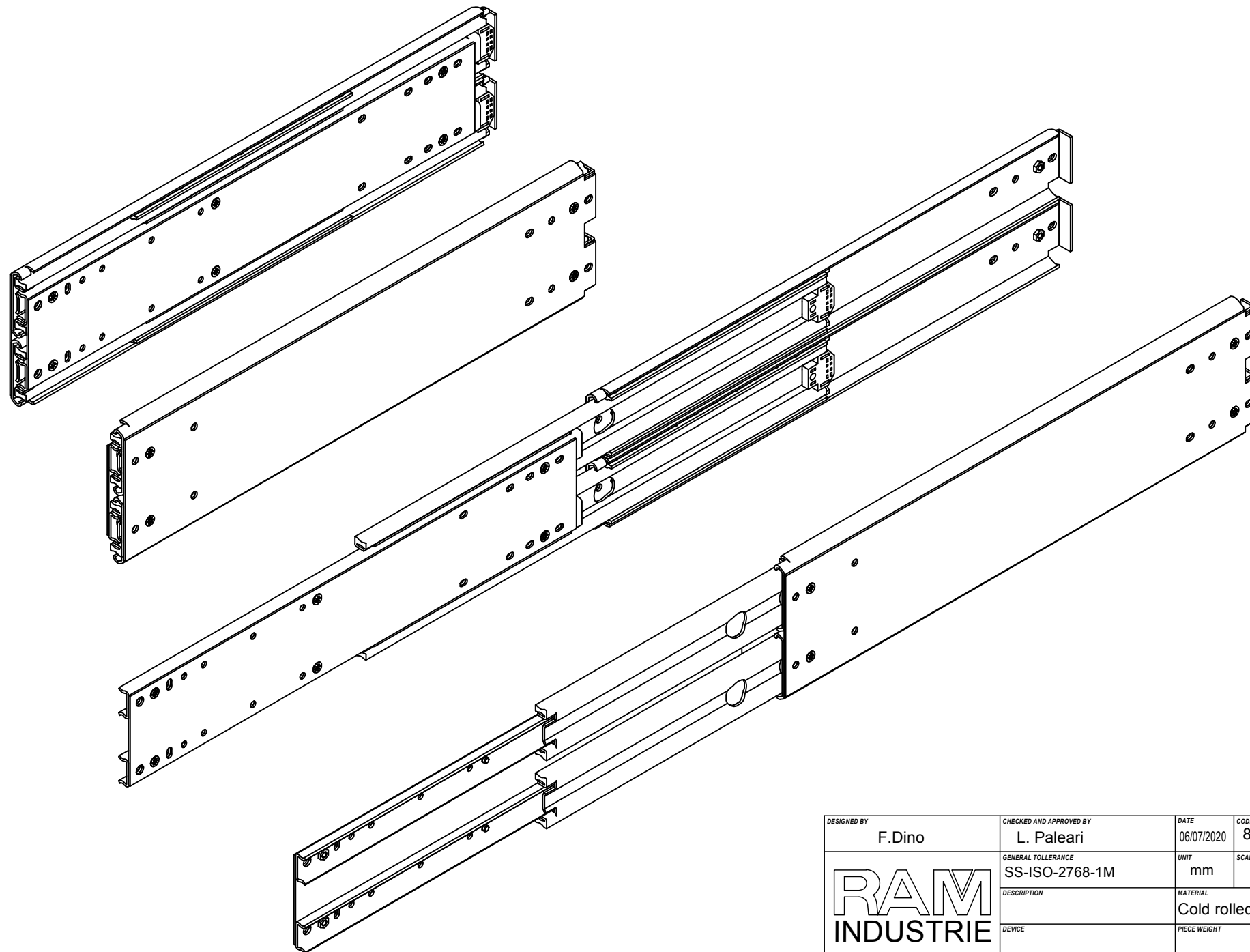

DESIGNED BY F.Dino	CHECKED AND APPROVED BY L. Paleari	DATE 06/07/2020	CODE 88600
	GENERAL TOLLERANCE SS-ISO-2768-1M	UNIT mm	SCALE SHEET 3 of 3
	DESCRIPTION	MATERIAL Cold rolled steel	
	DEVICE	PIECE WEIGHT	

Property of RAM Industrie.  
Without its written authorization the present drawing shall neither be used for construction anyway, communicated to third parties, nor reproduced.