

SEZ. A-A

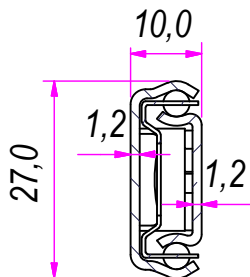

B (1:1)

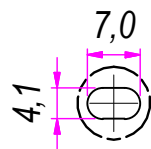

C (1:1)

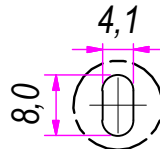

DESIGNED BY F.Dino	CHECKED AND APPROVED BY L. Paleari	REVISION	DATE 23/05/2016	CODE C28400
GENERAL TOLLERANCE SS-ISO-2768-1M			UNIT mm	SCALE 1 of 2
DESCRIPTION			MATERIAL Cold rolled steel	
DEVICE			PAIR WEIGHT 0,542 Kg	02C

Property of RAM Industrie.
Without its written authorization the present drawing shall neither be used for construction anyway, communicated to third parties, nor reproduced.

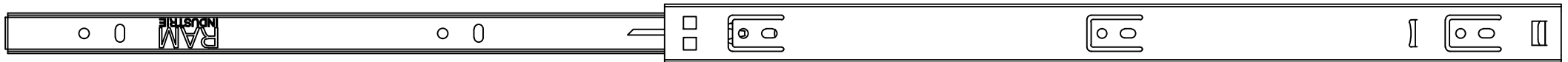

694,0

294,0

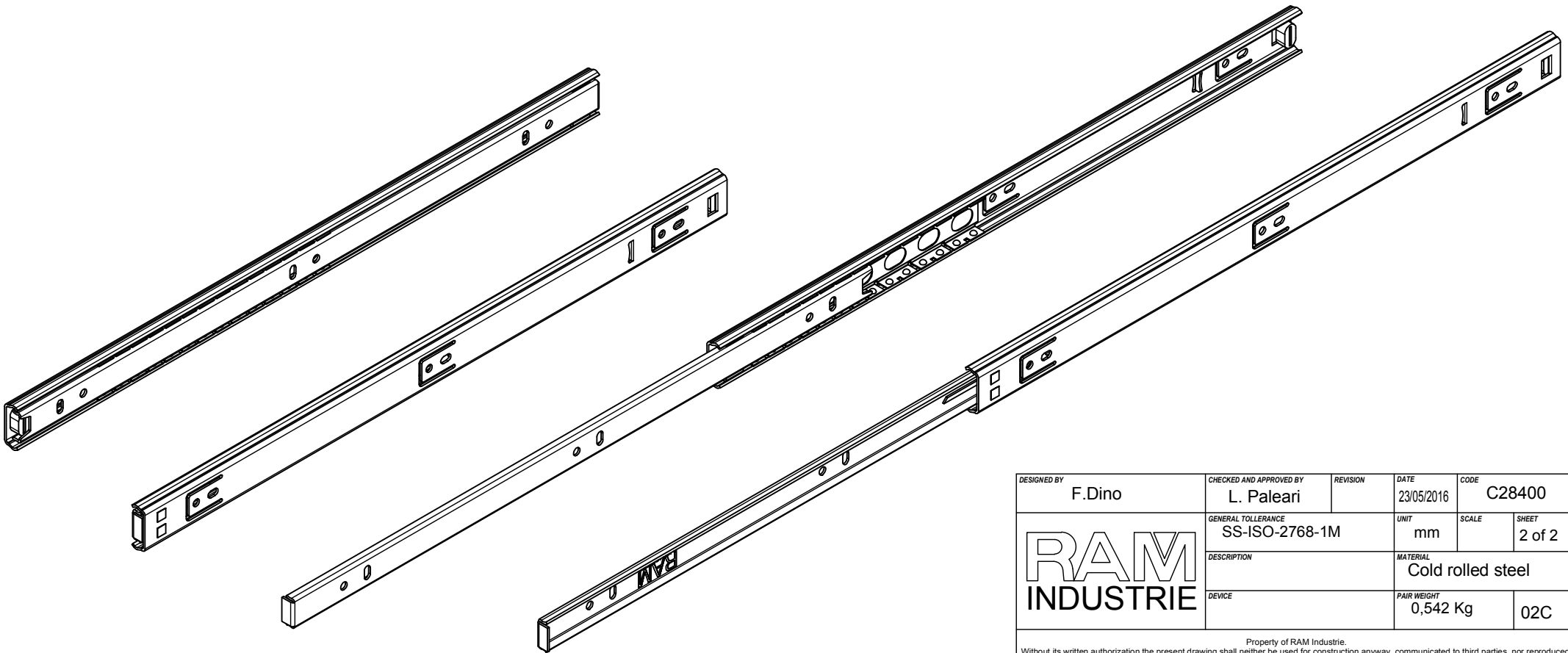
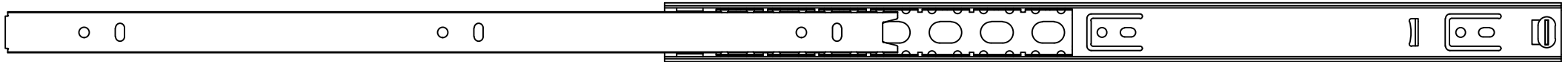

DESIGNED BY F.Dino	CHECKED AND APPROVED BY L. Paleari	REVISION	DATE 23/05/2016	CODE C28400
		GENERAL TOLLERANCE SS-ISO-2768-1M	UNIT mm	SCALE SHEET 2 of 2
		DESCRIPTION	MATERIAL Cold rolled steel	
DEVICE	PAIR WEIGHT 0,542 Kg		02C	

Property of RAM Industrie.
Without its written authorization the present drawing shall neither be used for construction anyway, communicated to third parties, nor reproduced.