

SEZ. A-A

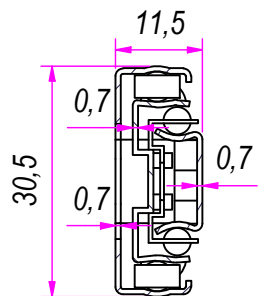

B (1:1)

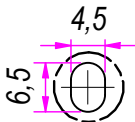

D (1:1)

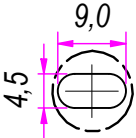

E (1:1)

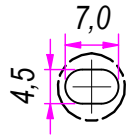

| | | | | |
|---|---------------------------------------|--|-------------------------------|---|
| DESIGNED BY F. Dino | CHECKED AND APPROVED BY L. Paleari | GENERAL TOLERANCE SS-ISO-2768-1M | DATE 20/03/2019 | CODE C31400 |
| | | PACKAGING Carton 40 sets/Packed R+R | UNIT mm | SHEET 1 of 2 |
| | | DESCRIPTION Black finishing (cataphoresis coating) | MATERIAL Cold rolled steel | |
| | | DEVICE | PAIR WEIGHT 0,428 Kg | 11C |
| Guide per cassetti; guide telescopiche Drawer slide; telescopic ball bearing slide Kugelführung; Teleskopschienen | | Coulisseries à billes; coulisse télescopique Guías para cajones; guía teleópica | | REVISION HISTORY DESCRIPTION DATE 20/03/2019 |
| Without its written authorization the present drawing shall neither be used for construction anyway, communicated to third parties, nor reproduced. | | | | |

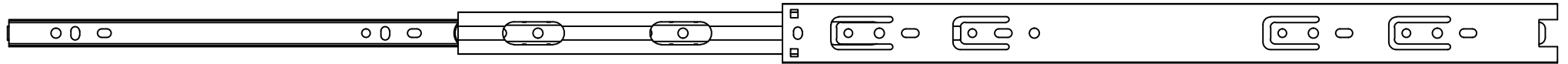

800,0

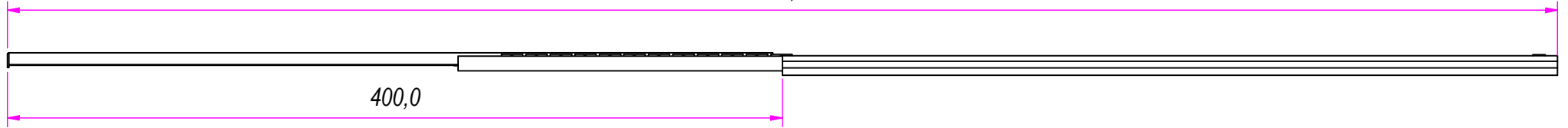

400,0

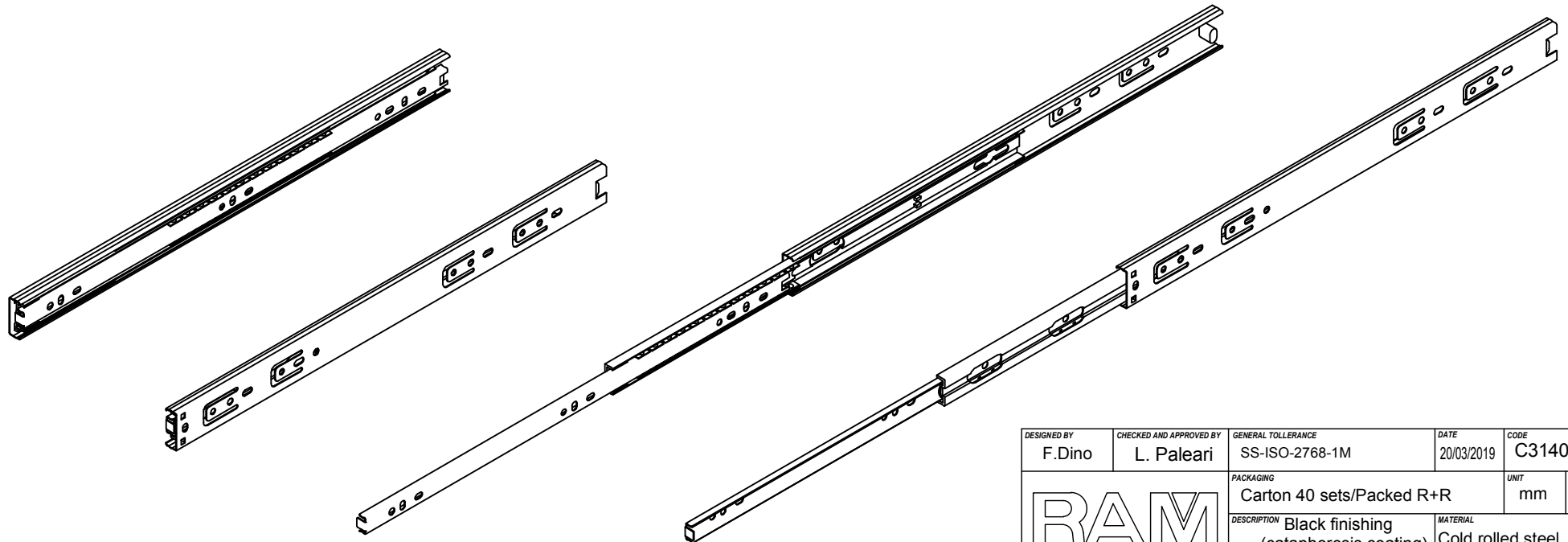
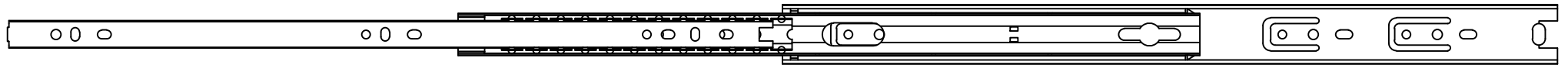

| | | | | |
|--|---------------------------------------|-------------------------------------|-------------------------------|-----------------|
| DESIGNED BY F.Dino | CHECKED AND APPROVED BY L. Paleari | GENERAL TOLERANCE SS-ISO-2768-1M | DATE 20/03/2019 | CODE C31400 |
| PACKAGING Carton 40 sets/Packed R+R | | | UNIT mm | SHEET 2 of 2 |
| DESCRIPTION Black finishing (cataphoresis coating) | | | MATERIAL Cold rolled steel | |
| DEVICE | | | PAIR WEIGHT 0,428 Kg | 11C |

RAM
INDUSTRIE

| | | REVISION HISTORY | |
|---|-----|------------------|------------|
| | REV | DESCRIPTION | DATE |
| Guide per cassetti; guide telescopiche | | | |
| Coulisses à billes; coulisse télescopique | | | |
| Drawer slide; telescopic ball bearing slide | 1a | | 20/03/2019 |
| Guías para cajones; guía teleópica | | | |
| Kugelführung; Teleskopschienen | | | |

Property of RAM Industrie.
Without its written authorization the present drawing shall neither be used for construction anyway, communicated to third parties, nor reproduced.