

INDICAZIONE PER DIMENSIONI INDIVIDUALI  
INDICAZIONE PER DIMENSIONI INDIVIDUALI  
TOLERANCE INDICATIONS ISO 2768-mH  
Numeri di riferimento (mm)

0,5	3	6	10	15	20	30	40	50	63	80	100	125	160	200	250	315	400
±0,2	±0,3	±0,5	±0,8	±1,2	±2	±3	±4	±5	±7	±10	±15	±20	±30	±40	±50	±70	±100

THIS DRAWING IS THE EXCLUSIVE PROPERTY OF RAM INDUSTRIE (THE COMPANY)  
WITHOUT ANY PRIOR WRITTEN AUTHORIZATION OF THE COMPANY  
THIS DRAWING CANNOT BE USED FOR CONSTRUCTION, NEITHER TRANSFERRED  
TO ANY THIRD PARTY OR EVEN PARTIALLY REPRODUCED.  
THE COMPANY WILL LEGALLY DEFEND ITS OWN RIGHTS

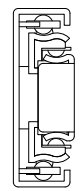
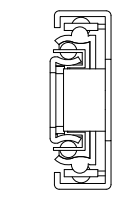
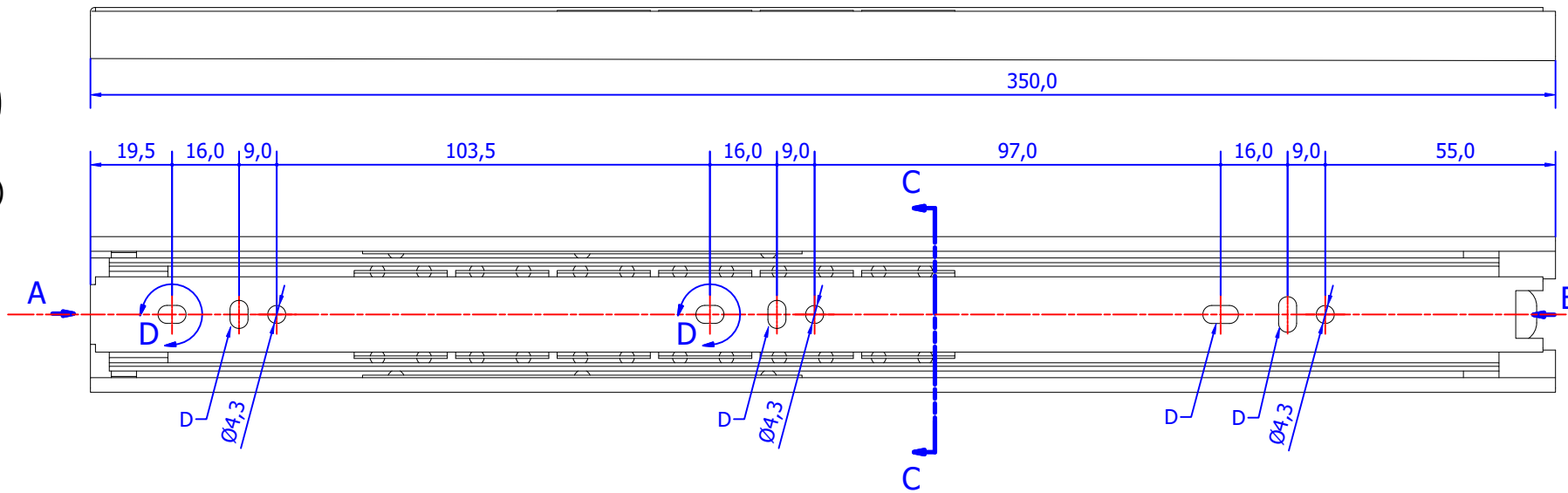
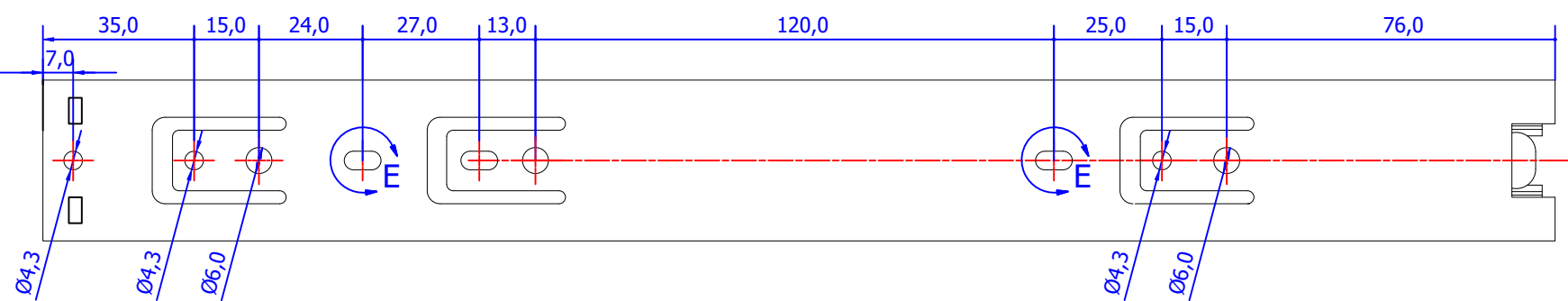
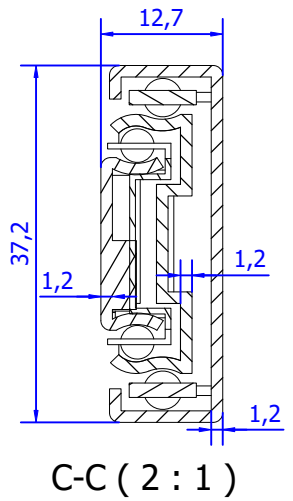
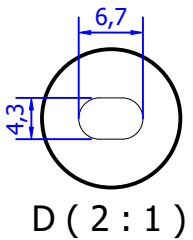
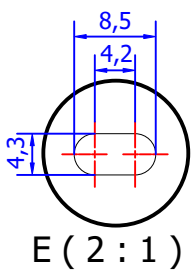

DESIGNED BY A. d'Alesio	CHECKED AND APPROVED BY T. Grassi	GENERAL TOLLERANCE SS-ISO-2768-1M	DATE 15/12/2023	CODE C36350
		DESCRIPTION	MATERIAL	UNIT mm
		DEVICE	PAIR WEIGHT WITH CARTON	SHEET 1 of 2
			PACKAGING Carton 1 piece	

Property of RAM industrie  
Without its written authorization the present drawing shall neither be used for construction anyway, communicated to third parties, nor reproduced.

INDICAZIONE PER DIMENSIONI SENZA TOLLERANZA INDIVIDUALE  
 INDICAZIONE PER DIMENSIONI SENZA TOLLERANZA INDIVIDUALE  
 TOLERANCE INDICATIONS ISO 2768-mH  
 Nominal dimensions (mm)

0.5	3	0.2	±0.2	±0.3	±0.5	±0.8	±1.2	±2	±3	±4
10	6	10								
30		30								
100		100								
300		300								
1000		1000								
3000		3000								

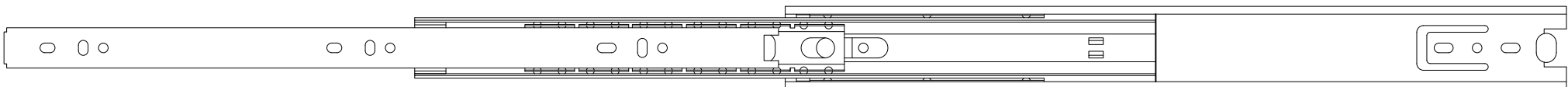
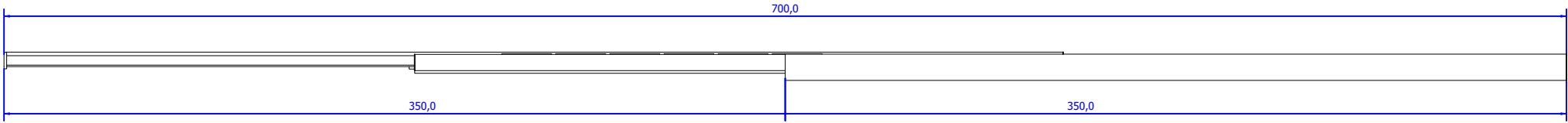
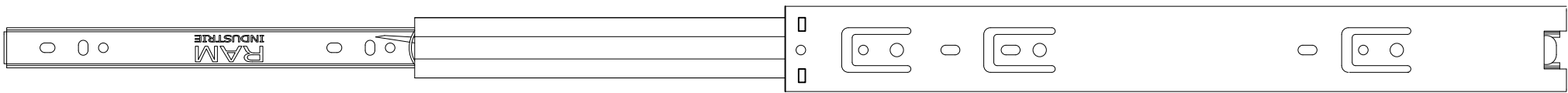

THIS DRAWING IS THE EXCLUSIVE PROPERTY OF RAM INDUSTRIE (THE COMPANY)  
 WITHOUT ANY PRIOR WRITTEN AUTHORIZATION OF THE COMPANY  
 THIS DRAWING CANNOT BE USED FOR CONSTRUCTION, NEITHER TRANSFERRED  
 TO ANY THIRD PARTY OR EVEN PARTIALLY REPRODUCED.  
 THE COMPANY WILL LEGALLY DEFEND ITS OWN RIGHTS

DESIGNED BY A. d'Alesio	CHECKED AND APPROVED BY T. Grassi	GENERAL TOLLERANCE SS-ISO-2768-1M	DATE 15/12/2023	CODE C36350	
		DECRPTION	MATERIAL	UNIT mm	SHEET 2 of 2
		DEVICE	PAIR WEIGHT WITH CARTON	PACKAGING Carton 1 piece	

Property of RAM industrie  
 Without its written authorization the present drawing shall neither be used for construction anyway, communicated to third parties, nor reproduced.