

A (1,5:1)

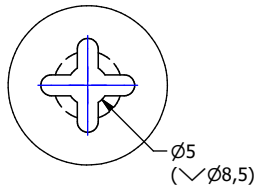

B (1,5:1)

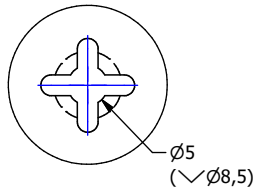

C-C (1:1)

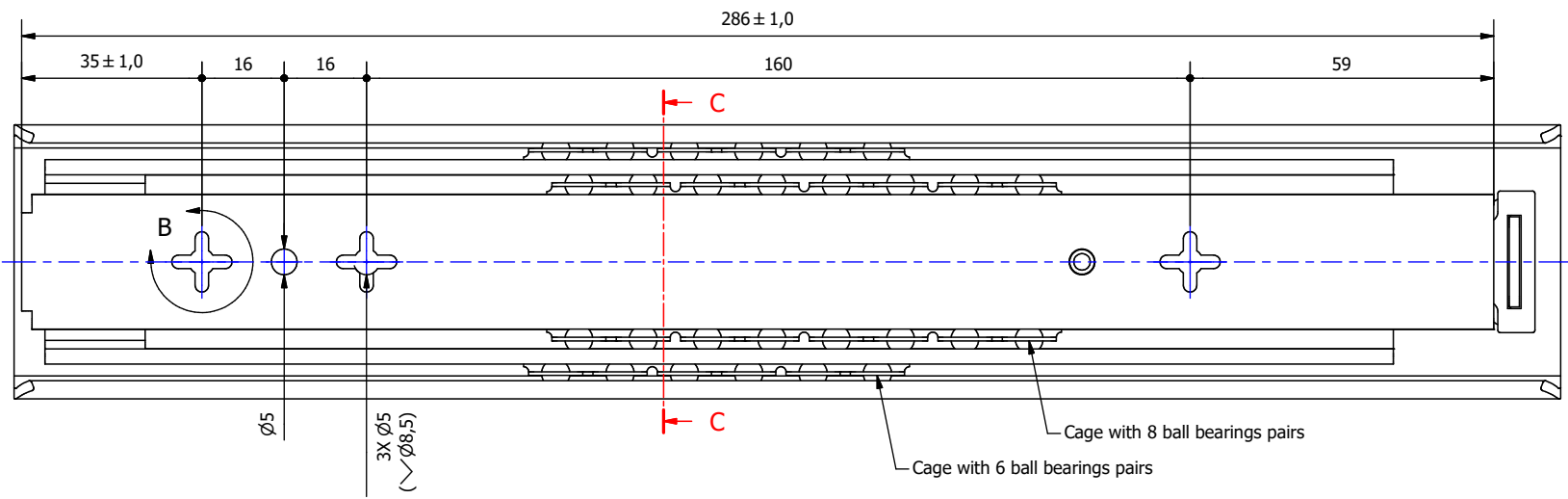
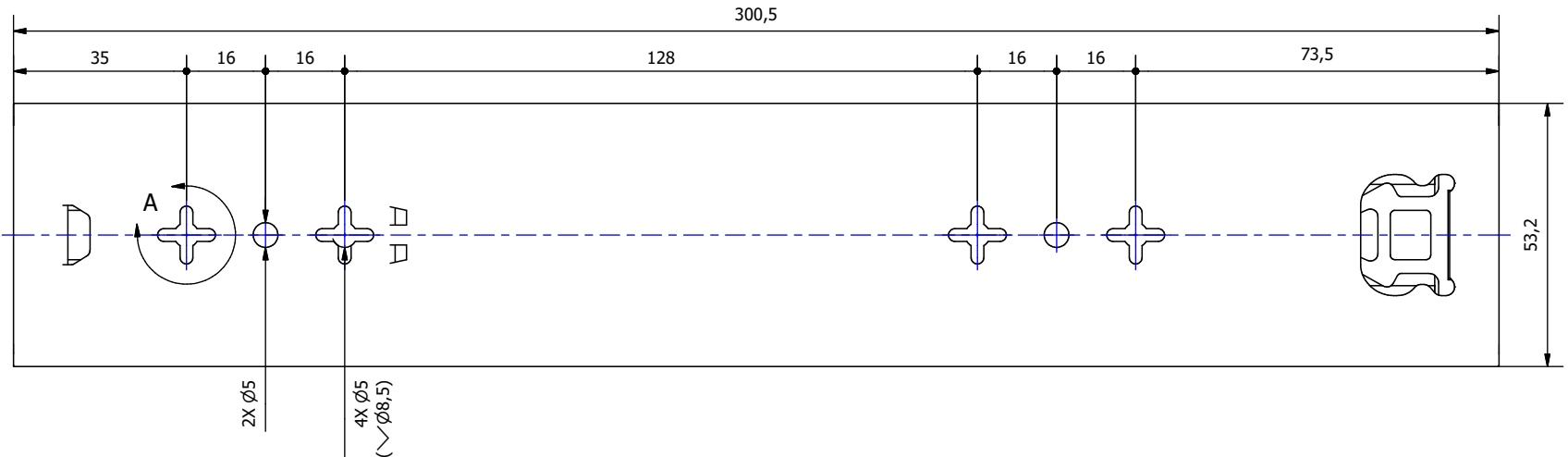
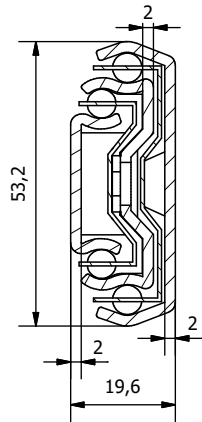

DESIGNED BY Paula	CHECKED AND APPROVED BY Assia	DATE 16/03/2026	CODE F58300
GENERAL TOLLERANCE SS-ISO-2768-1M		UNIT A3	SCALE 1:1
DESCRIPTION		MATERIAL Cold rolled steel	
DEVICES		PAIR WEIGHT 1,57 kg	REVISION

Property of Ram Industrie
without its written authorization, the present drawing shall neither
be used for construction anyway, communicated to third parts, nor reproduced

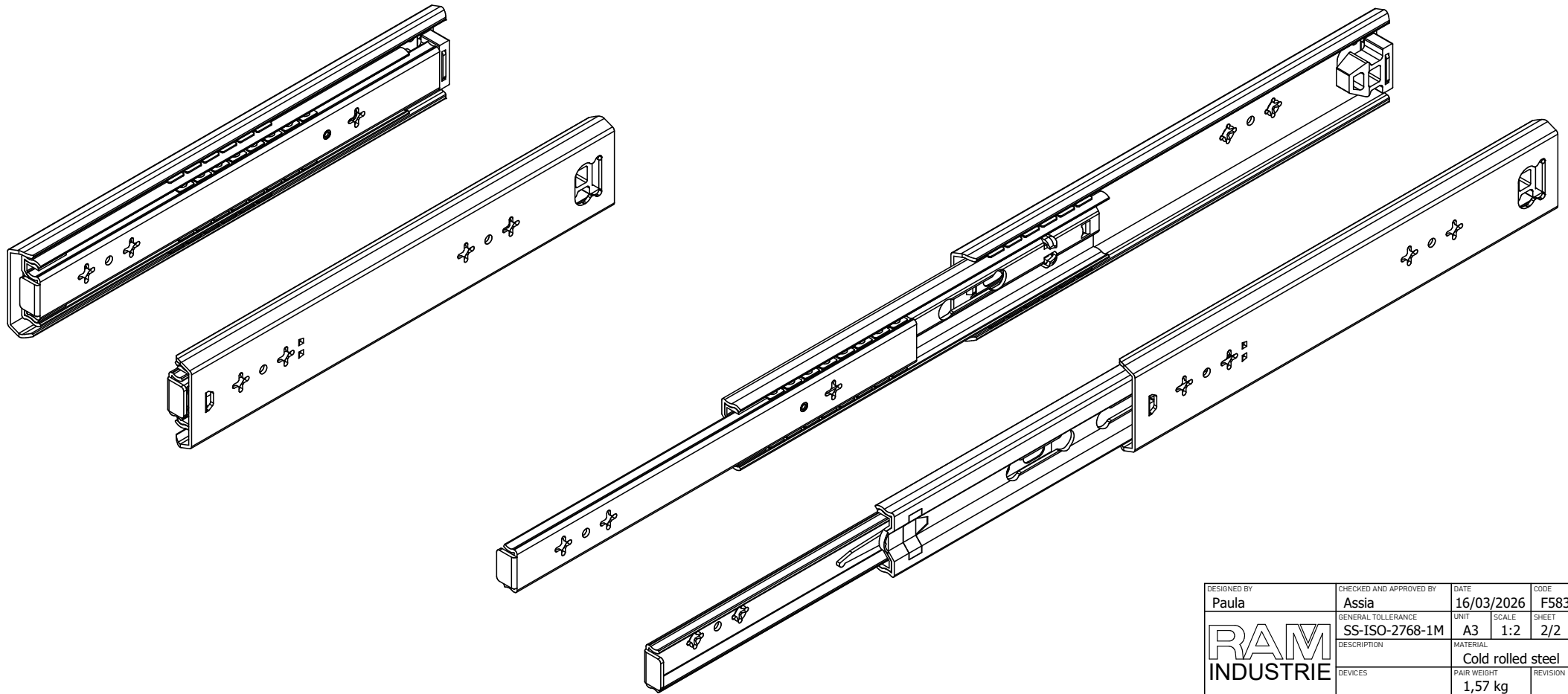
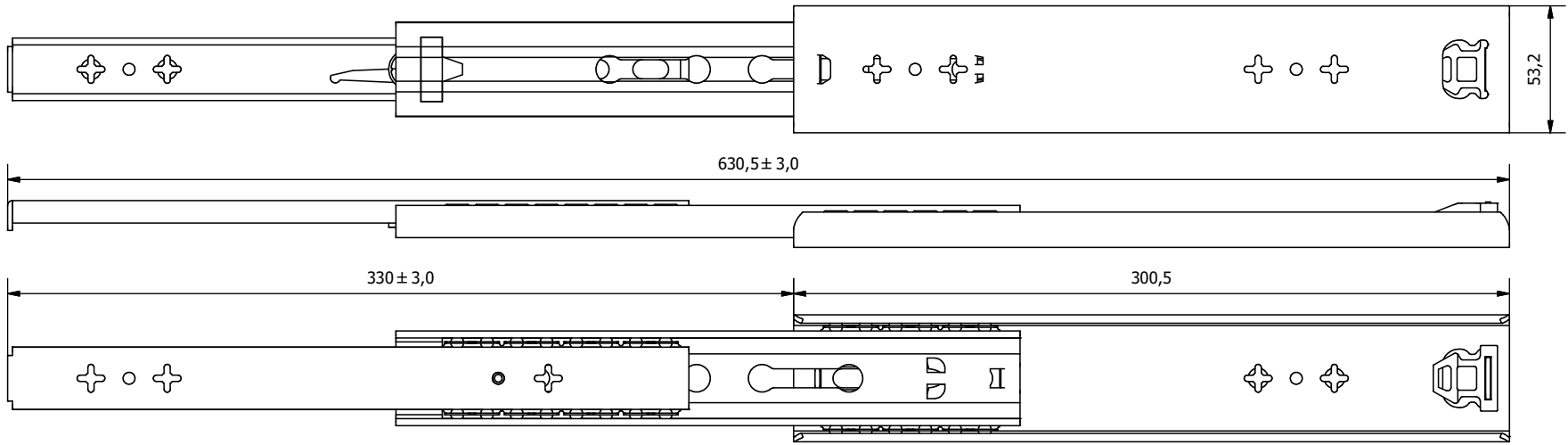

DESIGNED BY Paula	CHECKED AND APPROVED BY Assia	DATE 16/03/2026	CODE F58300
GENERAL TOLERANCE SS-ISO-2768-1M		UNIT A3	SCALE 1:2
DESCRIPTION RAM INDUSTRIE		MATERIAL Cold rolled steel	
DEVICES		PAIR WEIGHT 1,57 kg	REVISION

Property of Ram Industrie
without its written authorization, the present drawing shall neither
be used for construction anyway, communicated to third parts, nor reproduced