

INDICAZIONE PER DIMENSIONI INDIVIDUALI
INDICAZIONE PER DIMENSIONI SENZA INDIVIDUALITÀ

INDICAZIONE PER DIMENSIONI INDIVIDUALI
TOLLERANCE INDICATIONS ISO 2768-mH

0,5	3	6	10	15	20	30	40	50	63	80	100	125	160	200	250	315	400	500	630	800	1000
±0,2	±0,3	±0,5	±0,8	±1,2	±2	±3	±4	±5	±7	±10	±15	±20	±30	±40	±50	±70	±100	±150	±200	±300	±400

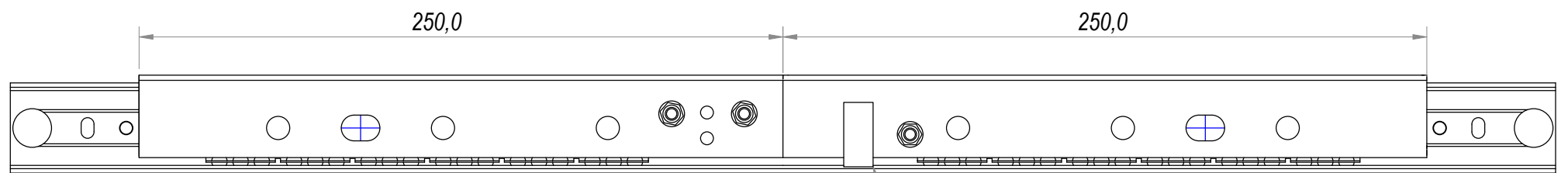
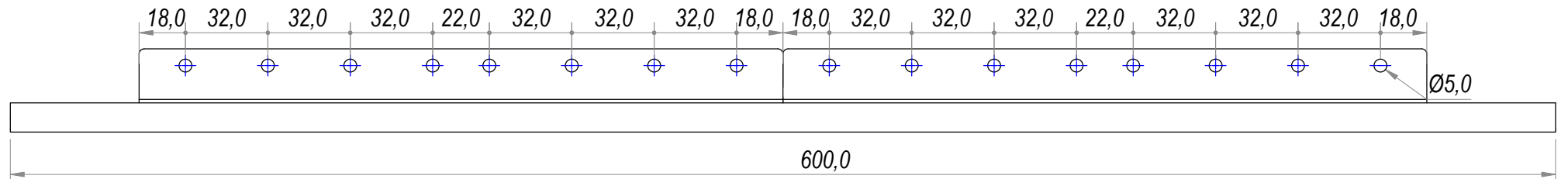
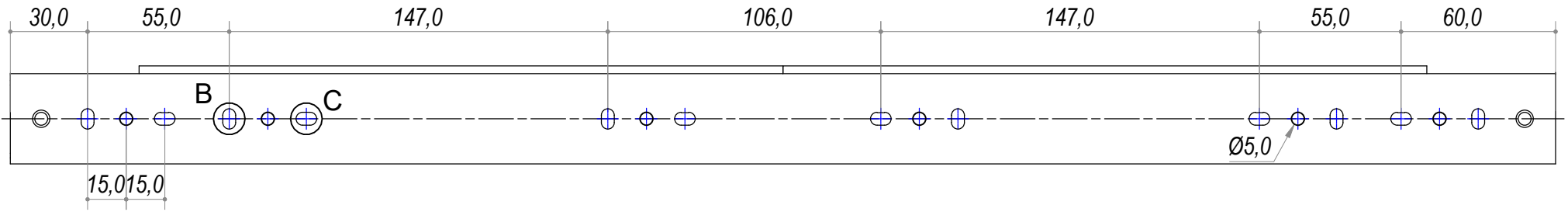

SEZ. A-A

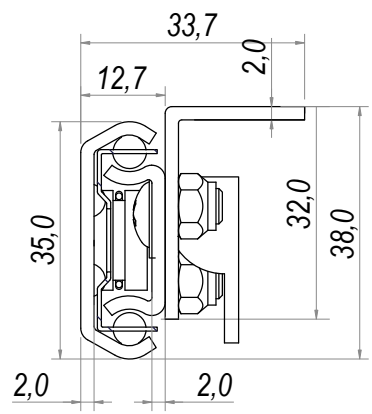

B (1:1)

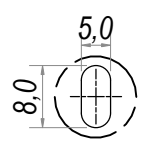

C (1:1)

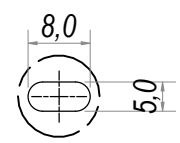

DESIGNED BY A. d'Alesio	CHECKED AND APPROVED BY T. Grassi	GENERAL TOLLERANCE SS-ISO-2768-1M	DATE 18/12/2023	CODE F93600	
		DESCRIPTION	MATERIAL	UNIT mm	SHEET 1 of 2
		DEVICE	PAIR WEIGHT WITH CARTON	PACKAGING Carton 1 piece	

THIS DRAWING IS THE EXCLUSIVE PROPERTY OF RAM INDUSTRIE (THE COMPANY) WITHOUT ANY PRIOR WRITTEN AUTHORIZATION OF THE COMPANY THIS DRAWING CANNOT BE USED FOR CONSTRUCTION, NEITHER TRANFERRED TO ANY THIRD PARTY OR EVEN PARTIALLY REPRODUCED. THE COMPANY WILL LEGALLY DEFEND ITS OWN RIGHTS

Property of RAM industrie
Without its written authorization the present drawing shall neither be used for construction anyway, communicated to third parties, nor reproduced.

INDICAZIONE PER DIMENSIONI INDIVIDUALI
INDICAZIONE PER DIMENSIONI SENZA INDIVIDUALITÀ

TOLLERANCE INDICATIONS ISO 2768-mH

Number of decimals (mm)	0.1	0.2	0.3	0.4	0.5	0.6	0.8	1.0	1.2	1.5	2.0	3.0	4.0
3	±0.2	±0.3	±0.5	±0.8	±1.2	±2	±3	±4					
2													
1													
0													

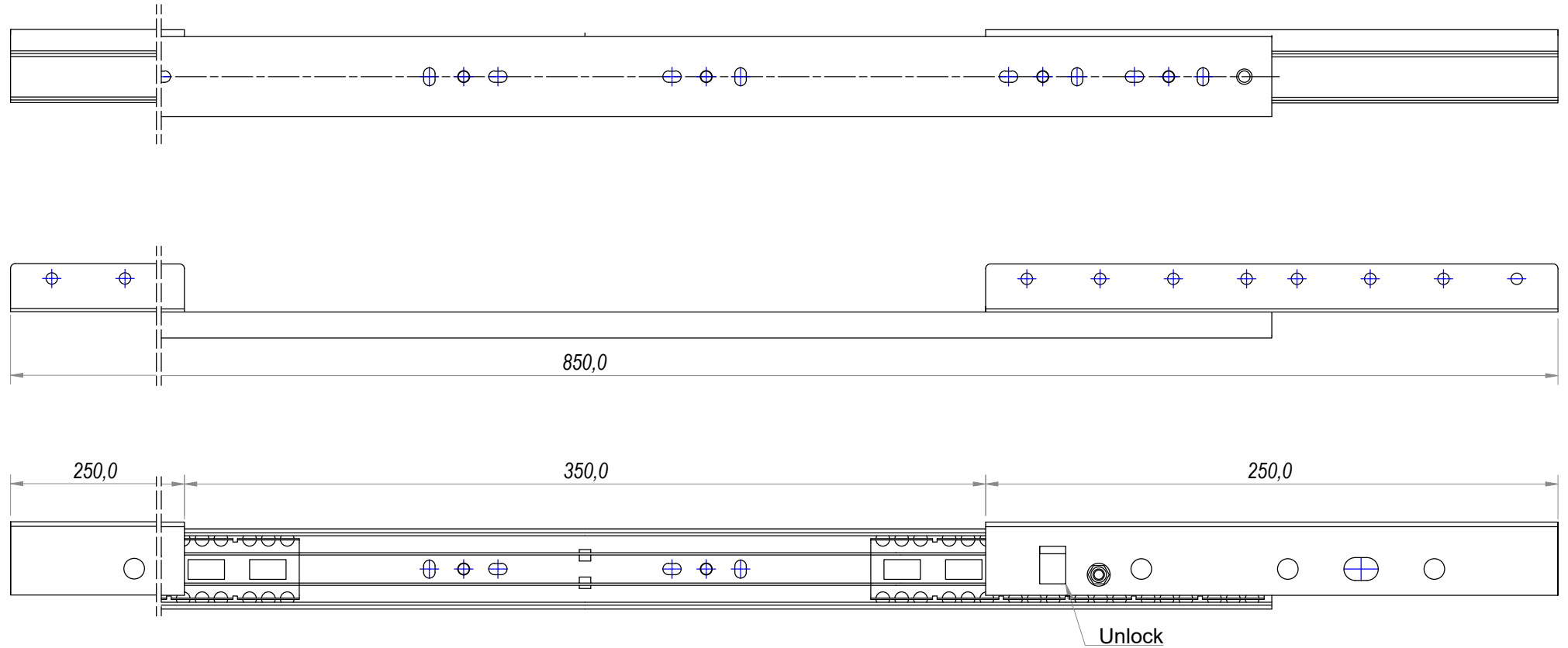

THIS DRAWING IS THE EXCLUSIVE PROPERTY OF RAM INDUSTRIE (THE COMPANY)
 WITHOUT ANY PRIOR WRITTEN AUTHORIZATION OF THE COMPANY
 THIS DRAWING CANNOT BE USED FOR CONSTRUCTION, NEITHER TRANSFERRED
 TO ANY THIRD PARTY OR EVEN PARTIALLY REPRODUCED.
 THE COMPANY WILL LEGALLY DEFEND ITS OWN RIGHTS

DESIGNED BY A. d'Alesio	CHECKED AND APPROVED BY T. Grassi	GENERAL TOLLERANCE SS-ISO-2768-1M	DATE 18/12/2023	CODE F93600	
		DESCRIPTION	MATERIAL	UNIT mm	SHEET 2 of 2
		DEVICE	PAIR WEIGHT WITH CARTON	PACKAGING Carton 1 piece	

Property of RAM industrie
 Without its written authorization the present drawing shall neither be used for construction anyway, communicated to third parties, nor reproduced.