

610,0

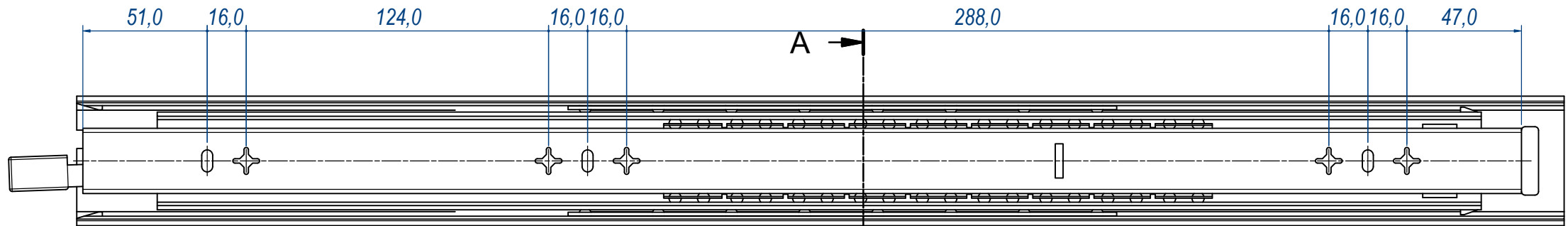

SEZ. A-A

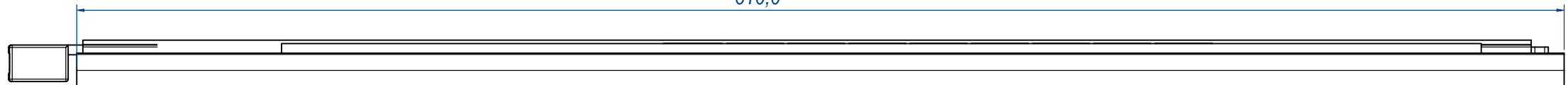
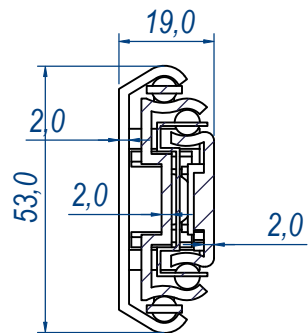

B (1:1)

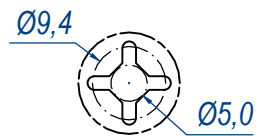

C (1:1)

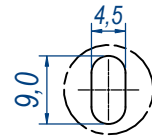

DESIGNED BY A. d'Alesio	CHECKED AND APPROVED BY T. Grassi	GENERAL TOLLERANCE SS-ISO-2768-1M	DATE 30/11/2023	CODE LE58600
RAM INDUSTRIE		DESCRIPTION	MATERIAL	UNIT mm
		DEVIATION	PAIR WEIGHT WITH CARTON	SHEET 1 of 2
			PACKAGING	Carton 1 piece

Property of RAM Industrie
Without its written authorization the present drawing shall neither be used for construction anyway, communicated to third parties, nor reproduced.

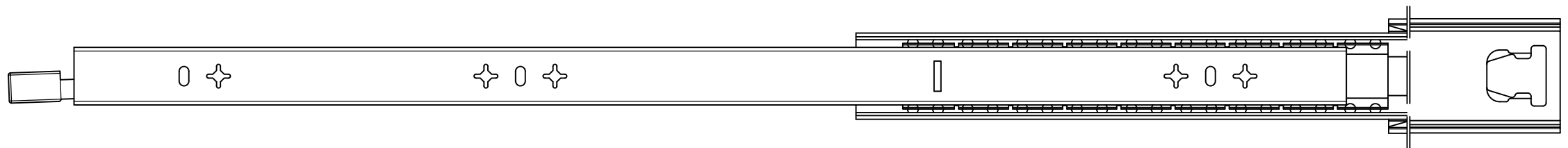
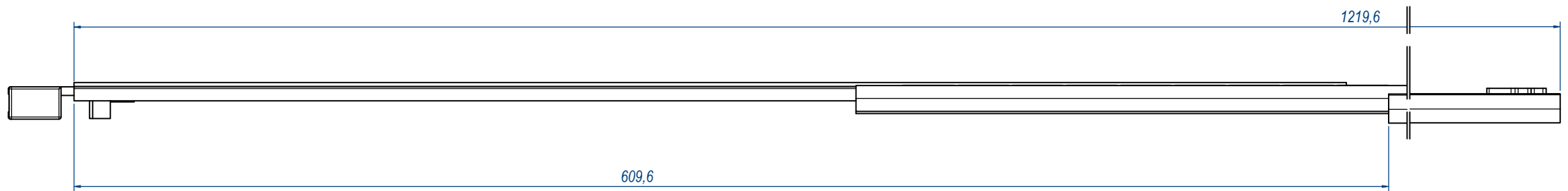
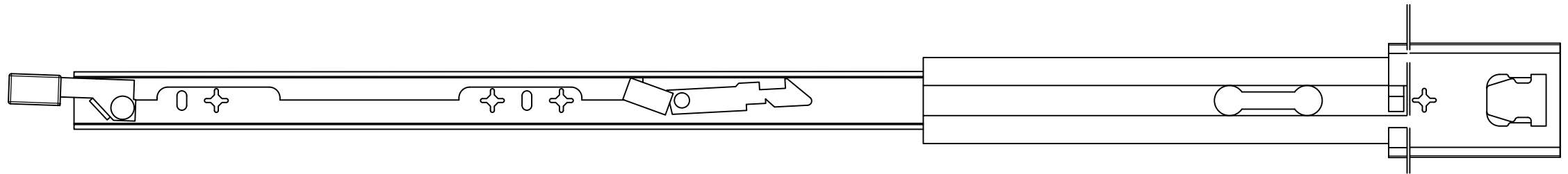

DESIGNED BY A. d'Alesio	CHECKED AND APPROVED BY T. Grassi	GENERAL TOLLERANCE SS-ISO-2768-1M	DATE 30/11/2023	CODE LE58600	
RAM INDUSTRIE		DESCRIPTION	MATERIAL	UNIT mm	SHEET 2 of 2
		DEVICE	PAIR WEIGHT WITH CARTON	PACKAGING Carton 1 piece	

Property of RAM Industrie
Without its written authorization the present drawing shall neither be used for construction anyway, communicated to third parties, nor reproduced.