

762,0

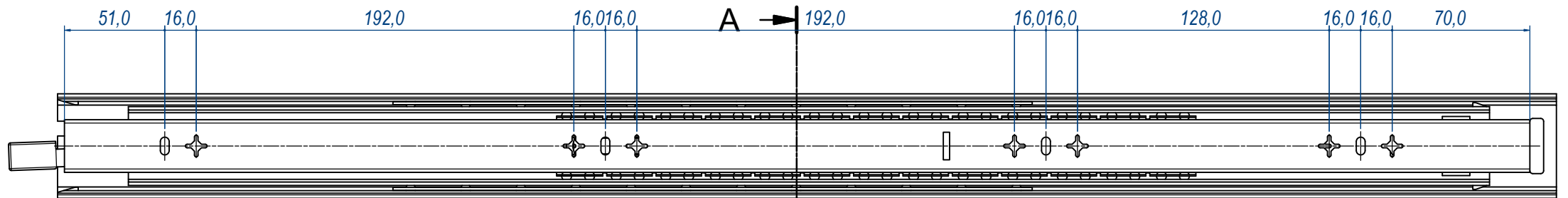

SEZ. A-A

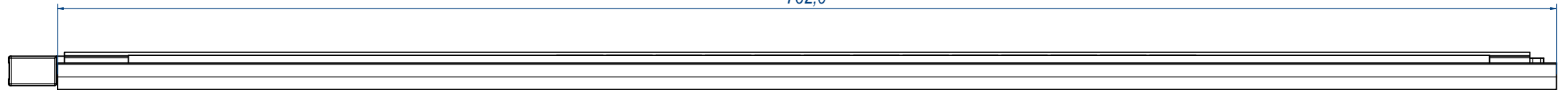
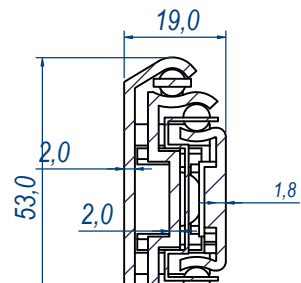

B (1:1)

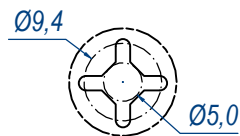

C (1:1)

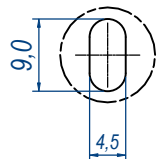

DESIGNED BY A. d'Alesio	CHECKED AND APPROVED BY T. Grassi	GENERAL TOLLERANCE SS-ISO-2768-1M	DATE 24/11/2023	CODE LE58750
		DESCRIPTION	MATERIAL	UNIT mm
		DEVICE	PAIR WEIGHT WITH CARTON	SHEET 1 of 2
			PACKAGING	Carton 1 piece

Property of RAM Industrie
Without its written authorization the present drawing shall neither be used for construction anyway, communicated to third parties, nor reproduced.

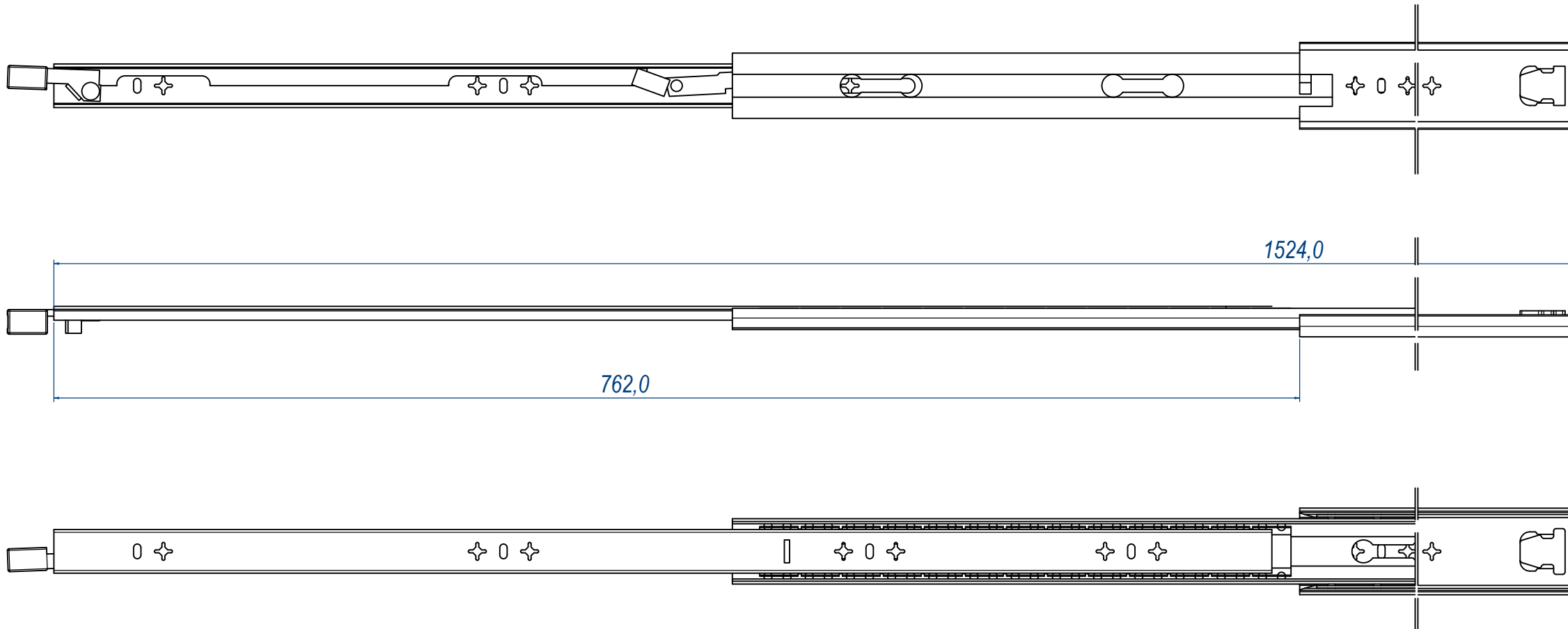

DESIGNED BY A. d'Alesio	CHECKED AND APPROVED BY T. Grassi	GENERAL TOLLERANCE SS-ISO-2768-1M	DATE 24/11/2023	CODE LE58750
RAM INDUSTRIE		DESCRIPTION	MATERIAL	UNIT mm
		DEVICE	PAIR WEIGHT WITH CARTON	PACKAGING Carton 1 piece

Property of RAM Industrie
Without its written authorization the present drawing shall neither be used for construction anyway, communicated to third parties, nor reproduced.