

SEZ. A-A

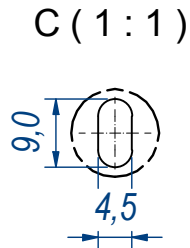

DESIGNED BY F.Dino	CHECKED AND APPROVED BY L. Paleari	REVISION	DATE 23/03/2016	CODE LI58350
GENERAL TOLLERANCE SS-ISO-2768-1M			UNIT mm	SHEET 1 of 2
DESCRIPTION			MATERIAL Zinc coated steel	
DEVICE Lock-in			PAIR WEIGHT 1,81 Kg	02C

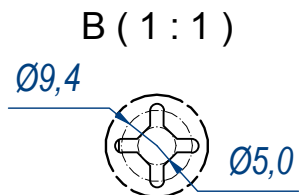
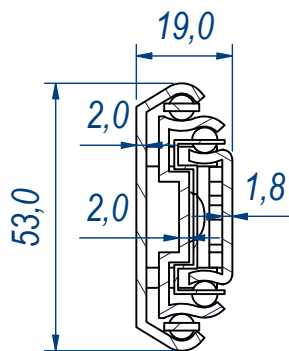
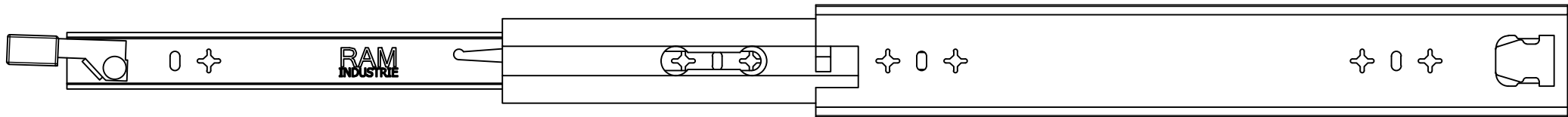

708,5

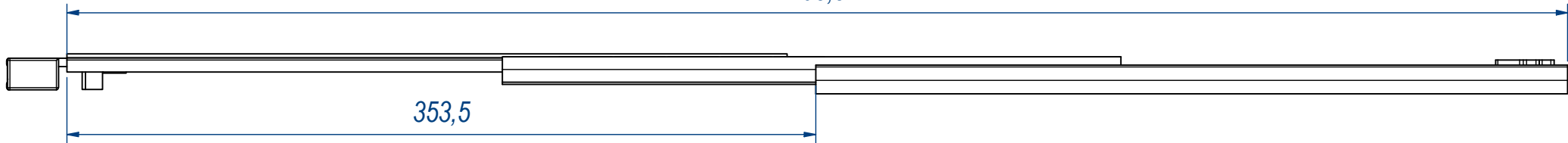

353,5

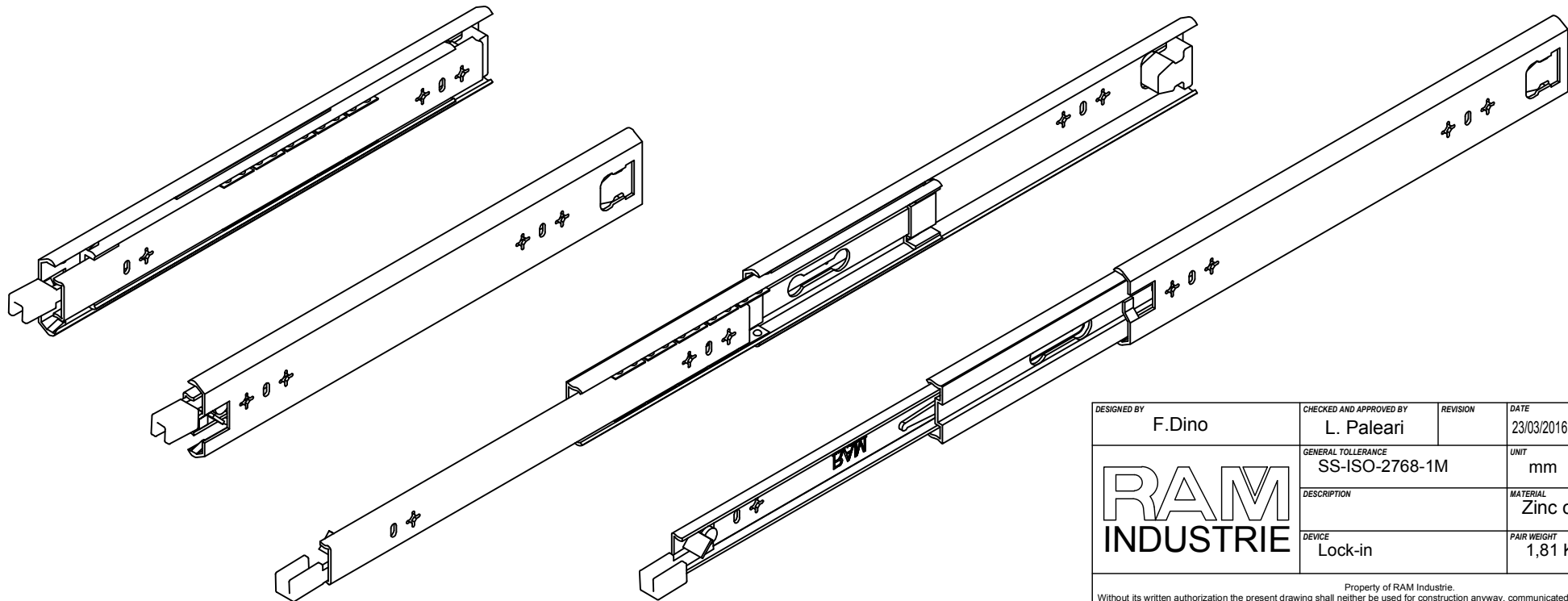
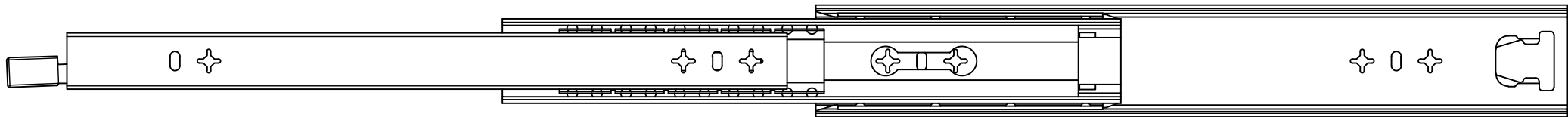

DESIGNED BY F.Dino	CHECKED AND APPROVED BY L. Paleari	REVISION	DATE 23/03/2016	CODE LI58350
		GENERAL TOLLERANCE SS-ISO-2768-1M	UNIT mm	SCALE SHEET 2 of 2
		DESCRIPTION	MATERIAL Zinc coated steel	
DEVICE Lock-in	PAIR WEIGHT 1,81 Kg		02C	

Property of RAM Industrie.
Without its written authorization the present drawing shall neither be used for construction anyway, communicated to third parties, nor reproduced.