

SEZ. A-A

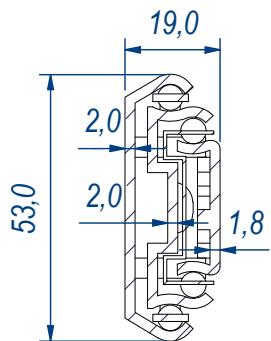

B (1:1)

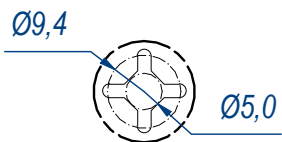

C (1:1)

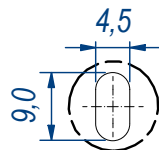

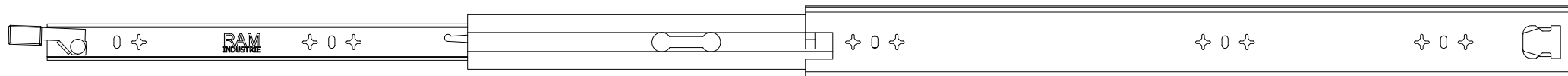

DESIGNED BY F.Dino	CHECKED AND APPROVED BY L. Paleari	REVISION	DATE 23/03/2016	CODE LI58550
GENERAL TOLERANCE SS-ISO-2768-1M			UNIT mm	SCALE 1 of 2
DESCRIPTION			MATERIAL Zinc coated steel	
DEVICE Lock-in			PAIR WEIGHT 3,034 Kg	02C

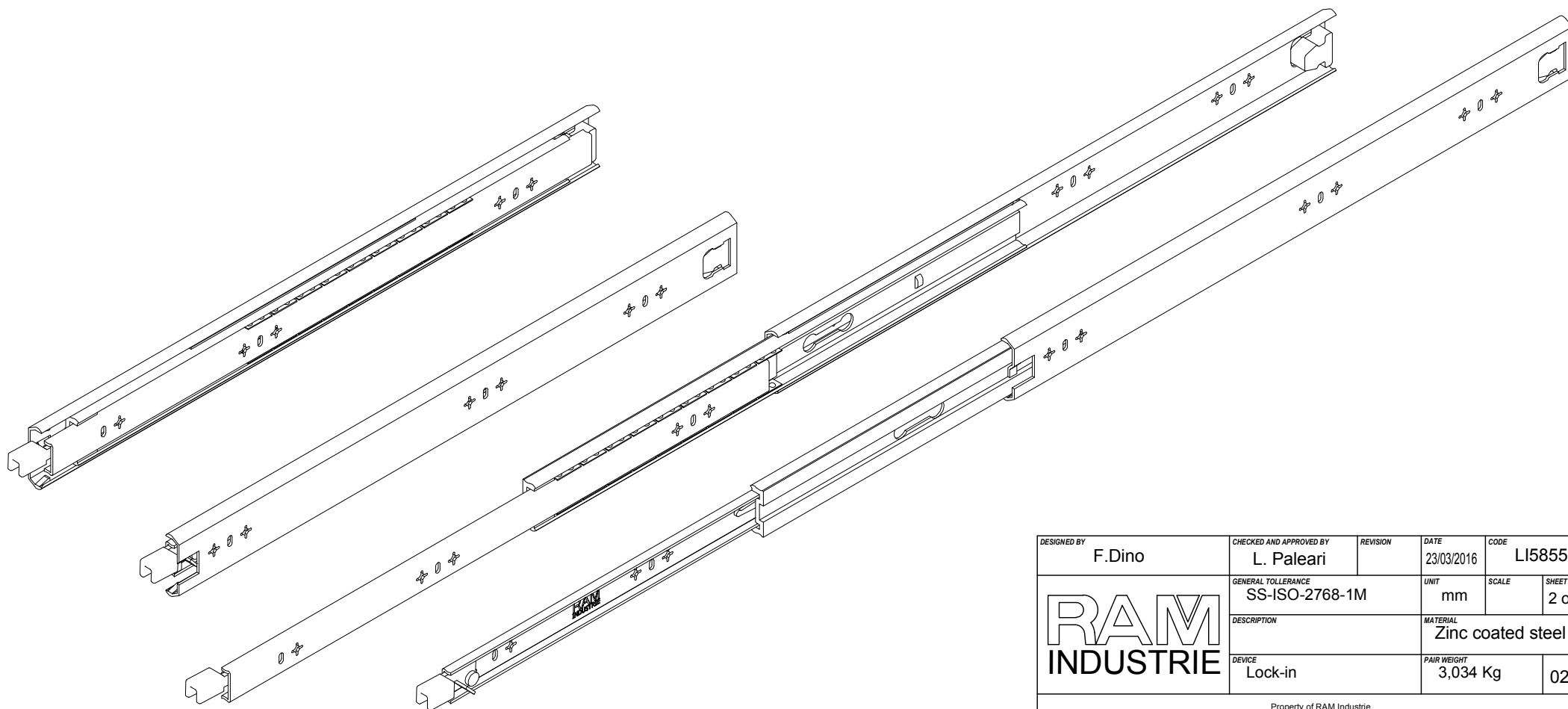
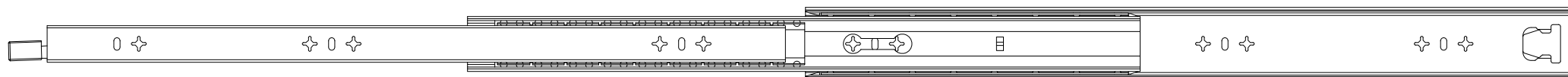

1119,0

560,0



DESIGNED BY F.Dino	CHECKED AND APPROVED BY L. Paleari	REVISION	DATE 23/03/2016	CODE LI58550
		GENERAL TOLLERANCE SS-ISO-2768-1M	UNIT mm	SCALE SHEET 2 of 2
		DESCRIPTION	MATERIAL Zinc coated steel	
DEVICE Lock-in	PAIR WEIGHT 3,034 Kg		02C	

Property of RAM Industrie.  
Without its written authorization the present drawing shall neither be used for construction anyway, communicated to third parties, nor reproduced.