

400,0

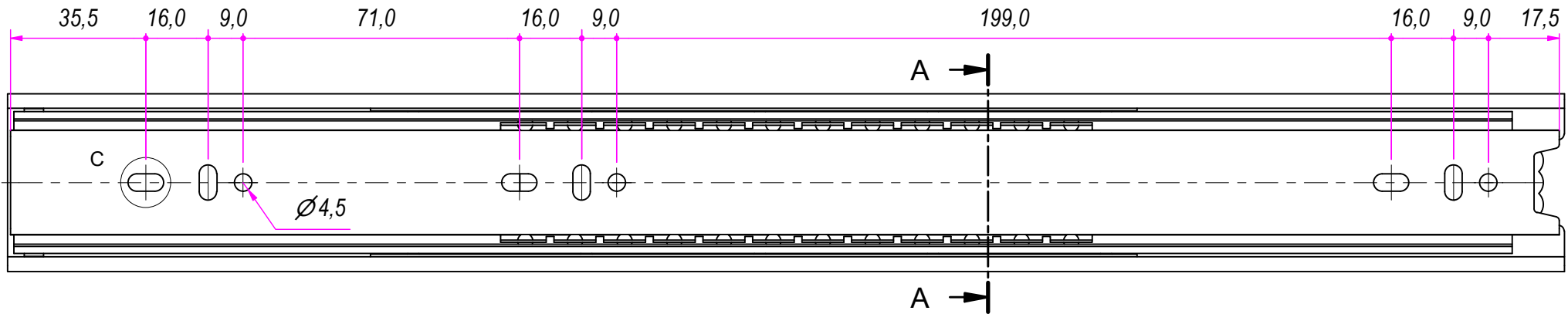

SEZ. A-A

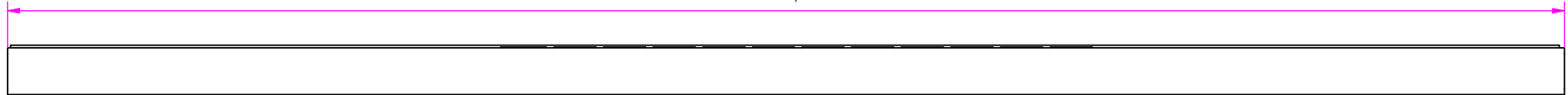
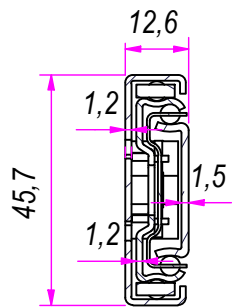

B (1:1)

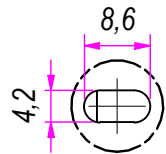

C (1:1)

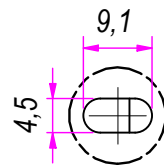

DESIGNED BY F.Dino	CHECKED AND APPROVED BY L. Paleari	REVISION	DATE 09/05/2016	CODE LO48400
		GENERAL TOLLERANCE SS-ISO-2768-1M	UNIT mm	SCALE 1 of 2
		DESCRIPTION Lock-out	MATERIAL Cold rolled steel	
		DEVICE	PAIR WEIGHT 1,244 Kg	02C

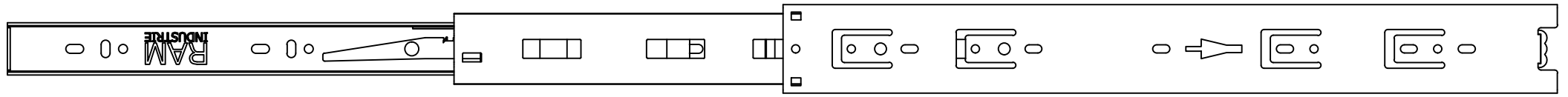

801,0

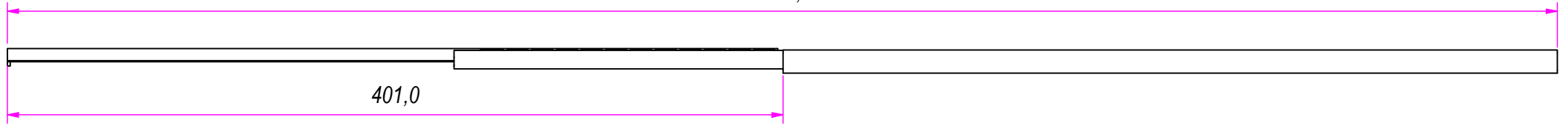

401,0

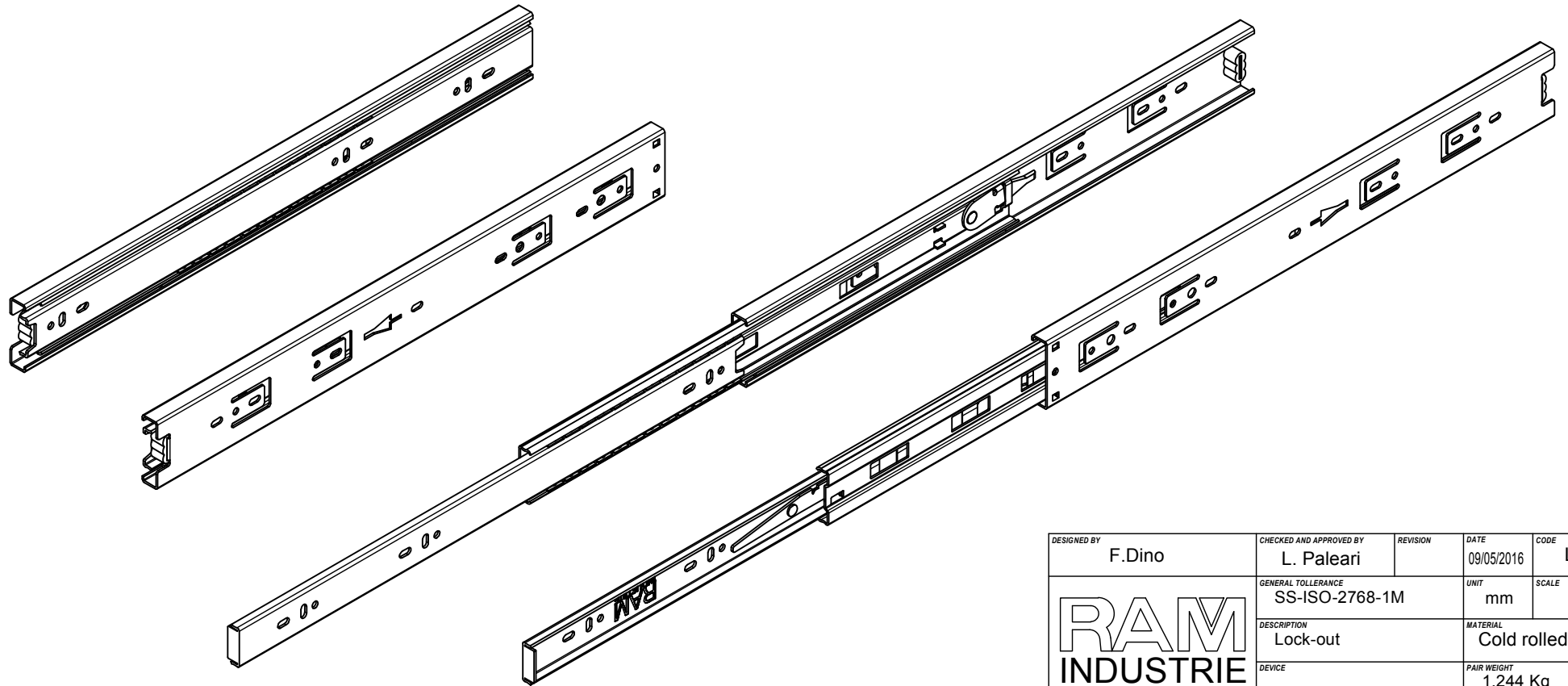
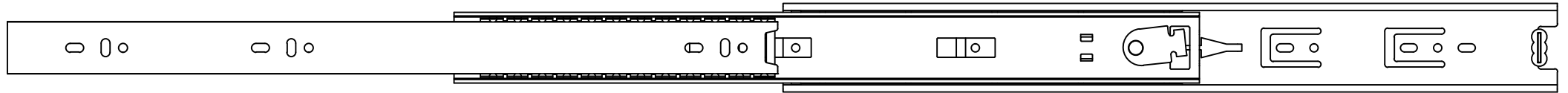

DESIGNED BY F.Dino	CHECKED AND APPROVED BY L. Paleari	REVISION	DATE 09/05/2016	CODE LO48400
		GENERAL TOLLERANCE SS-ISO-2768-1M	UNIT mm	SCALE SHEET 2 of 2
		DESCRIPTION Lock-out	MATERIAL Cold rolled steel	
DEVICE		PAIR WEIGHT 1,244 Kg	02C	

Property of RAM Industrie.
Without its written authorization the present drawing shall neither be used for construction anyway, communicated to third parties, nor reproduced.