

500,0

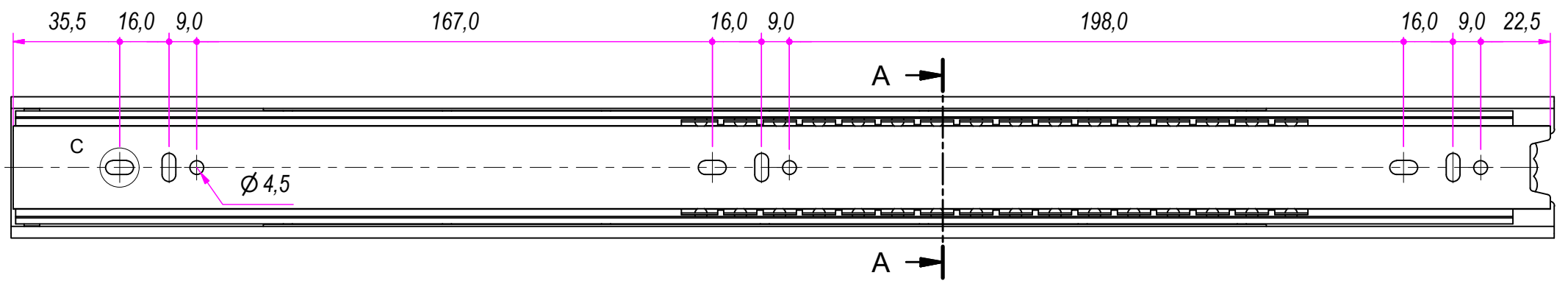

SEZ. A-A

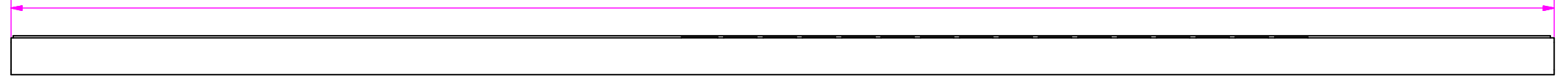
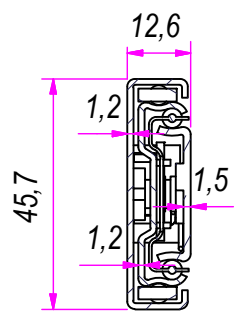

B (1:1)

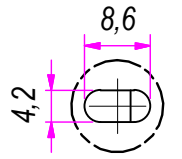

C (1:1)

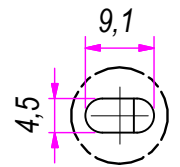

DESIGNED BY F.Dino	CHECKED AND APPROVED BY L. Paleari	REVISION	DATE 09/05/2016	CODE LO48500
		GENERAL TOLLERANCE SS-ISO-2768-1M	UNIT mm	SCALE SHEET 1 of 2
		DESCRIPTION Lock-out	MATERIAL Cold rolled steel	
		PAIR WEIGHT 1,56 Kg	02C	

Property of RAM Industrie.
Without its written authorization the present drawing shall neither be used for construction anyway, communicated to third parties, nor reproduced.

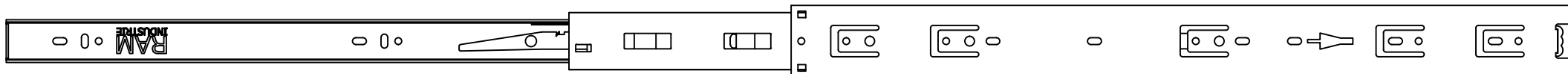

1002,0

502,0

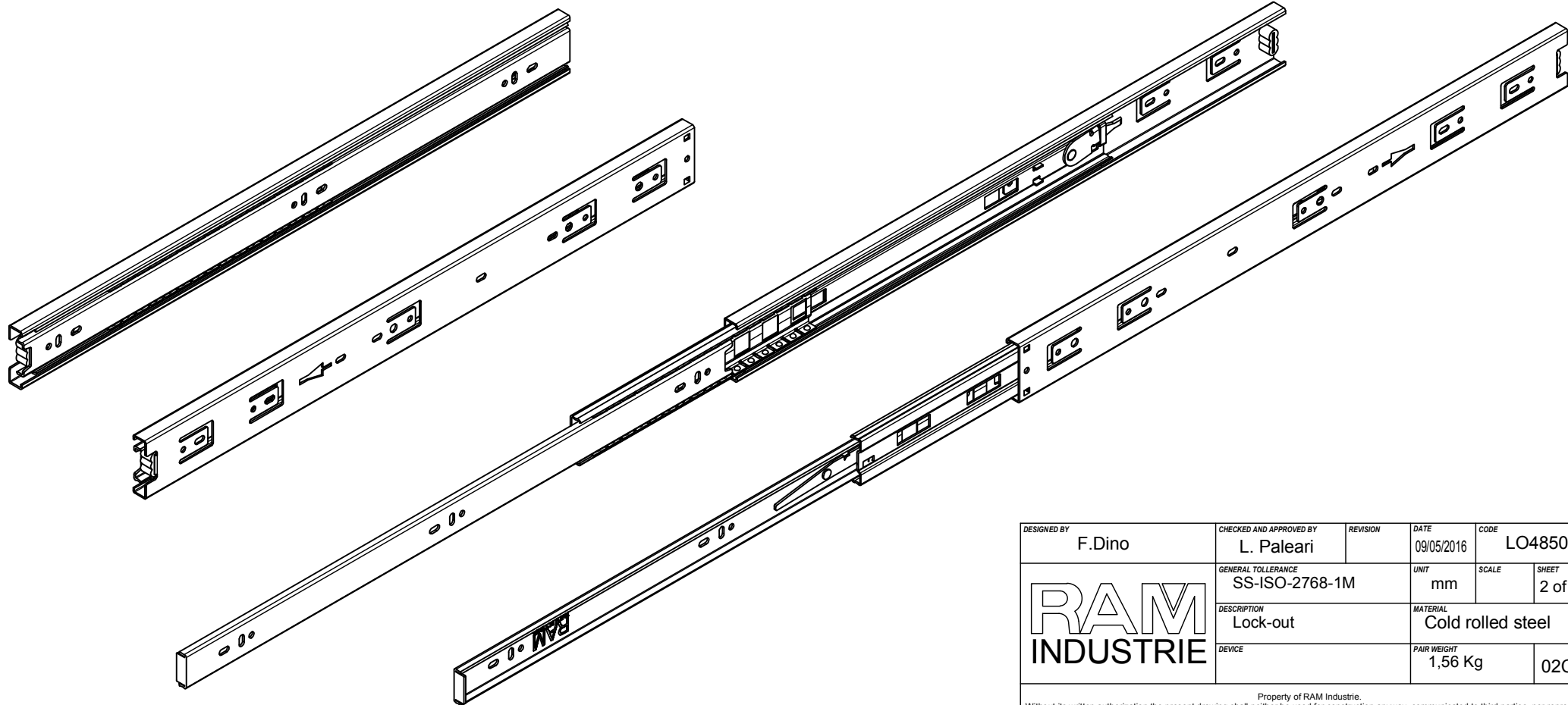
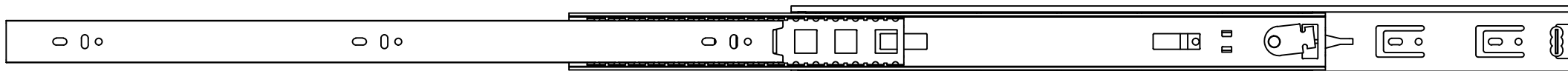
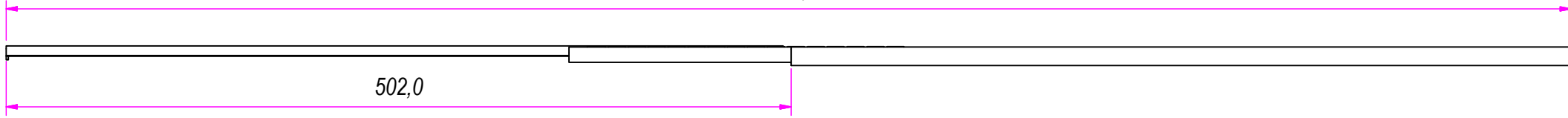

DESIGNED BY F.Dino	CHECKED AND APPROVED BY L. Paleari	REVISION	DATE 09/05/2016	CODE LO48500
		GENERAL TOLLERANCE SS-ISO-2768-1M	UNIT mm	SCALE SHEET 2 of 2
		DESCRIPTION Lock-out	MATERIAL Cold rolled steel	
DEVICE		PAIR WEIGHT 1,56 Kg	02C	

Property of RAM Industrie.
Without its written authorization the present drawing shall neither be used for construction anyway, communicated to third parties, nor reproduced.