

SEZ. A-A

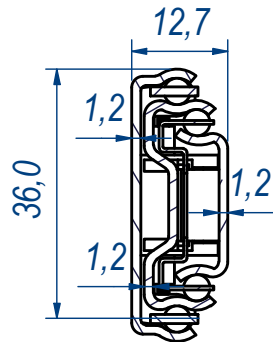

B (1:1)

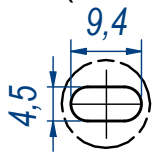

E (1:1)

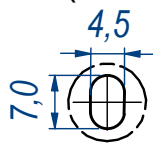

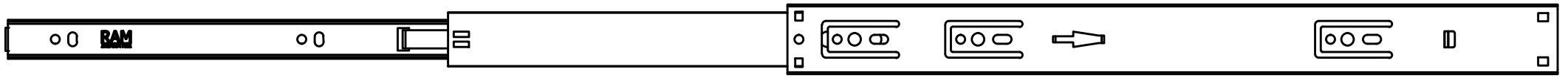

DESIGNED BY F.Dino	CHECKED AND APPROVED BY L. Paleari	REVISION	DATE 28/06/2016	CODE LO62400
GENERAL TOLLERANCE SS-ISO-2768-1M		UNIT mm	SCALE	SHEET 1 of 2
DESCRIPTION Lock-out		MATERIAL Zinc coated steel		
Self closing with double spring		PAIR WEIGHT 0,906 Kg	02T	

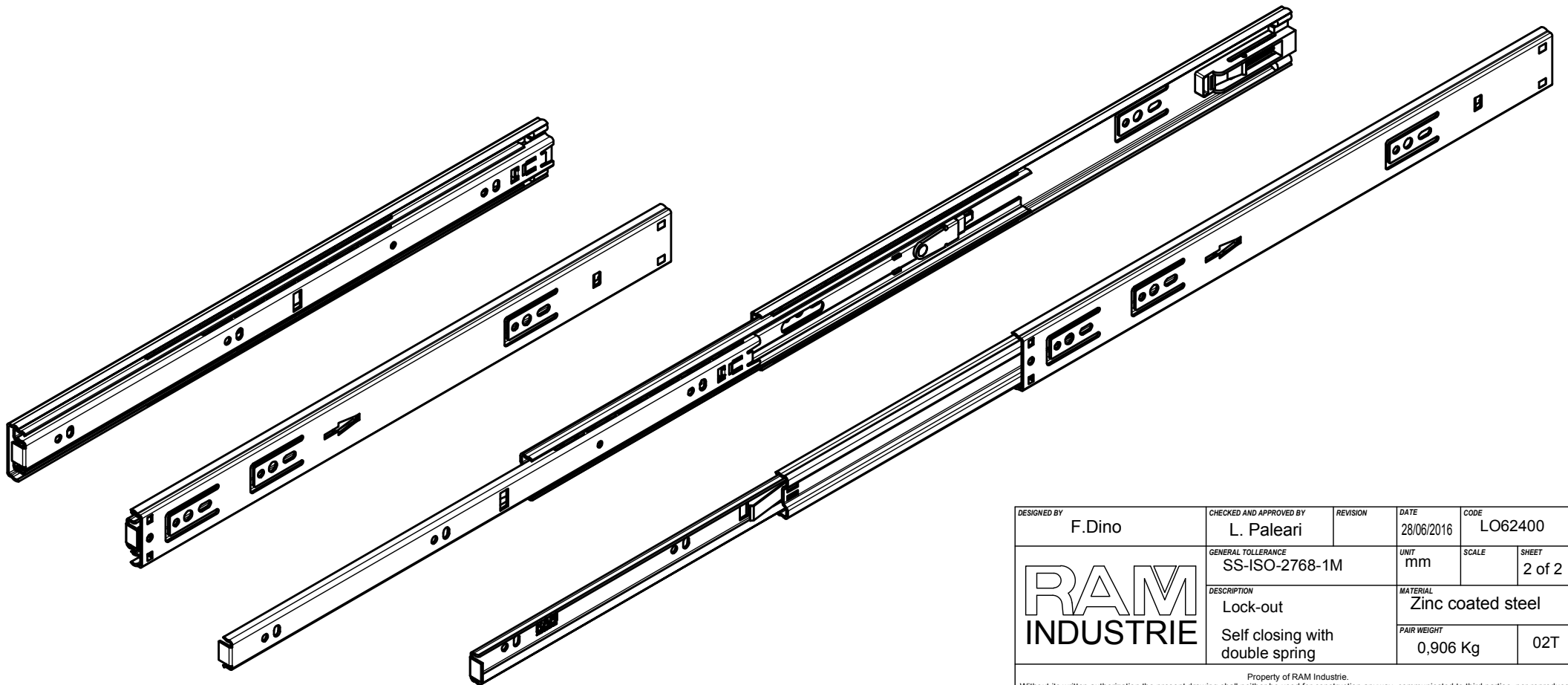
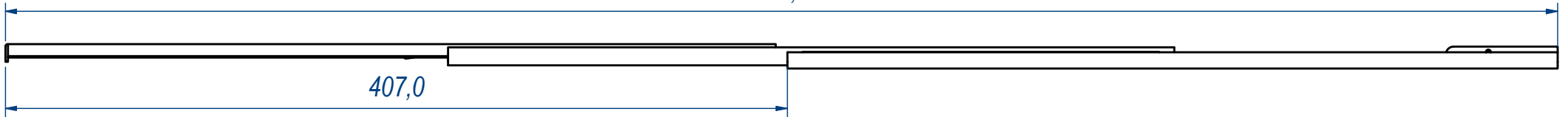

807,0

407,0



DESIGNED BY F.Dino	CHECKED AND APPROVED BY L. Paleari	REVISION	DATE 28/06/2016	CODE LO62400
		GENERAL TOLLERANCE SS-ISO-2768-1M	UNIT mm	SCALE SHEET 2 of 2
		DESCRIPTION Lock-out Self closing with double spring	MATERIAL Zinc coated steel	PAIR WEIGHT 0,906 Kg
<small>Property of RAM Industrie. Without its written authorization the present drawing shall neither be used for construction anyway, communicated to third parties, nor reproduced.</small>				