

SEZ. A-A

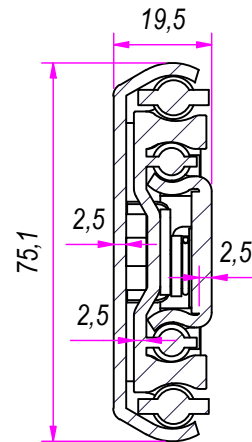

B (1:1)

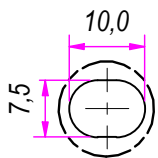

C (1:1)

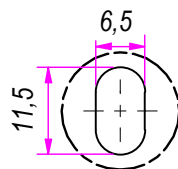

D (1:1)

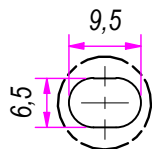

DESIGNED BY F.Dino	CHECKED AND APPROVED BY L. Paleari	REVISION	DATE 18/06/2021	CODE LO851000
RAM INDUSTRIE		GENERAL TOLLERANCE SS-ISO-2768-1M	UNIT mm	SCALE 1 of 2
		DESCRIPTION	MATERIAL Cold rolled steel	
DEVICE Lock-in and lock-out		PAIR WEIGHT 02C		

Property of RAM Industrie.
Without its written authorization the present drawing shall neither be used for construction anyway, communicated to third parties, nor reproduced.

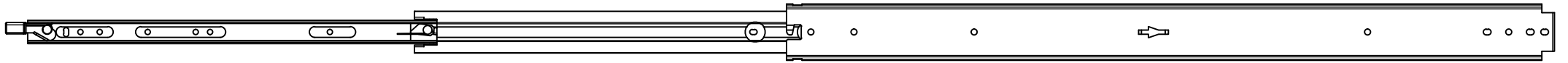

2016,0

1000,0

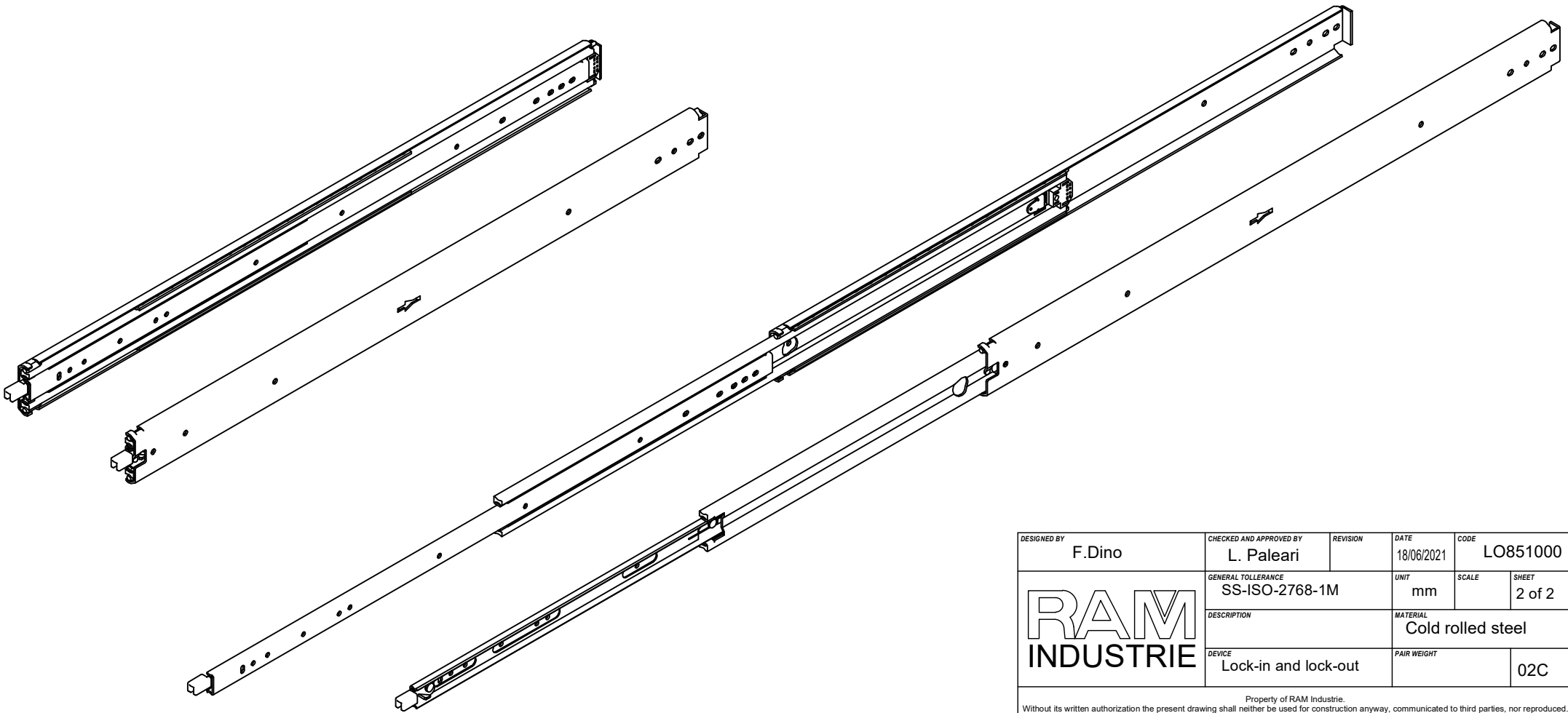
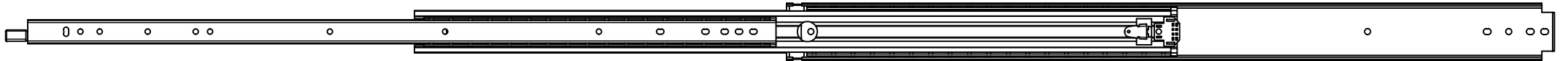

DESIGNED BY F.Dino	CHECKED AND APPROVED BY L. Paleari	REVISION	DATE 18/06/2021	CODE LO851000
GENERAL TOLLERANCE SS-ISO-2768-1M			UNIT mm	SCALE SHEET 2 of 2
DESCRIPTION RAM INDUSTRIE			MATERIAL Cold rolled steel	
DEVICE Lock-in and lock-out			PAIR WEIGHT 02C	

Property of RAM Industrie.
Without its written authorization the present drawing shall neither be used for construction anyway, communicated to third parties, nor reproduced.