

B (1:1)

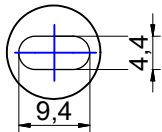

C (1:1)

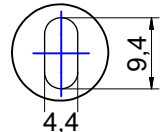

D (1:1)

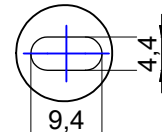

DESIGNED BY Assia	CHECKED AND APPROVED BY Loris	DATE 07/03/2024	CODE NE41350
		GENERAL TOLERANCE SS-ISO-2768-1M	UNIT SCALE
		DESCRIPTION	SHEET 1/2
DEVICES		MATERIAL Zinc coated steel	PAIR WEIGHT
<small>Property of Ram Industrie without its written authorization, the present drawing shall neither be used for construction anyway, communicated to third parts, not reproduced</small>			

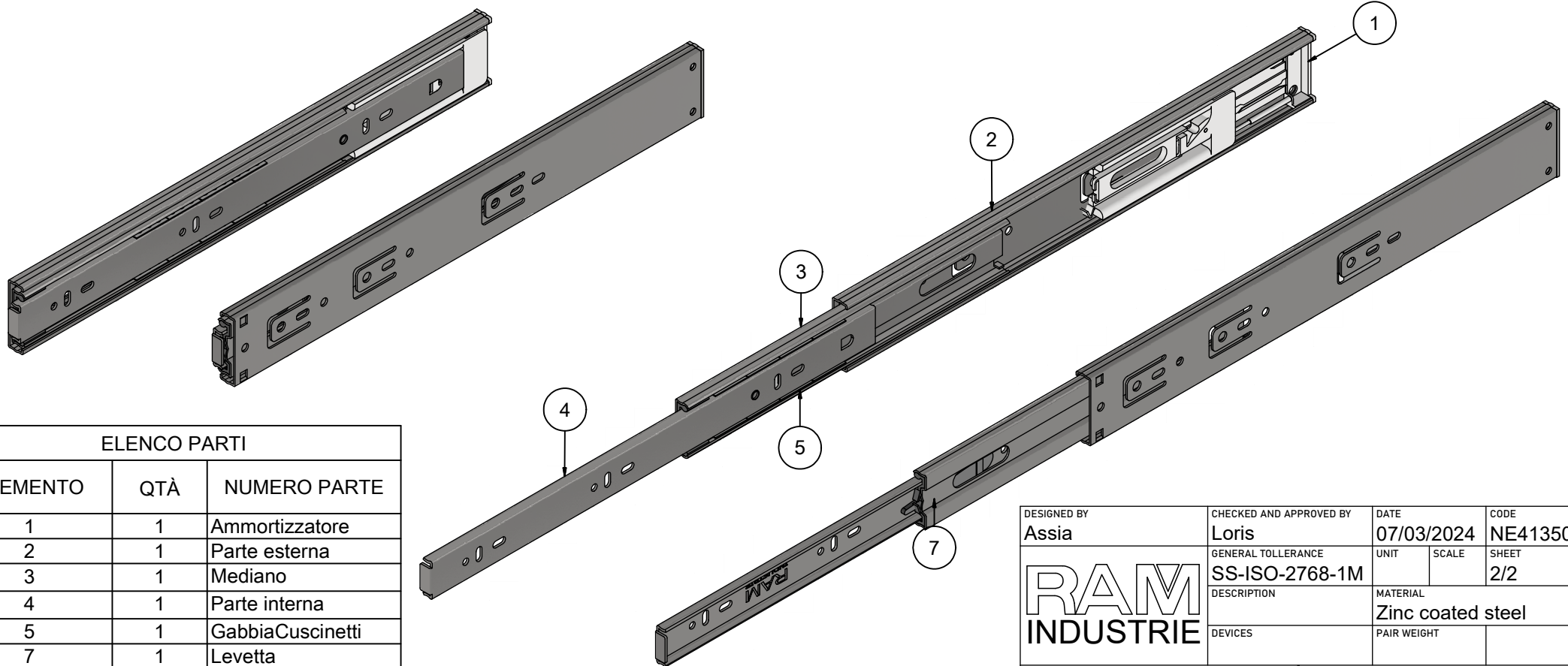
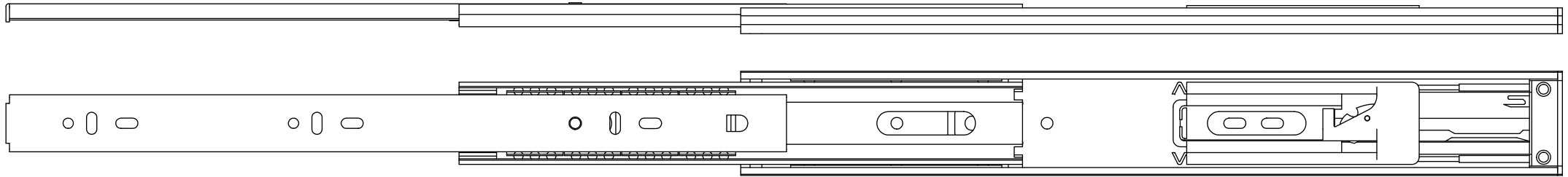
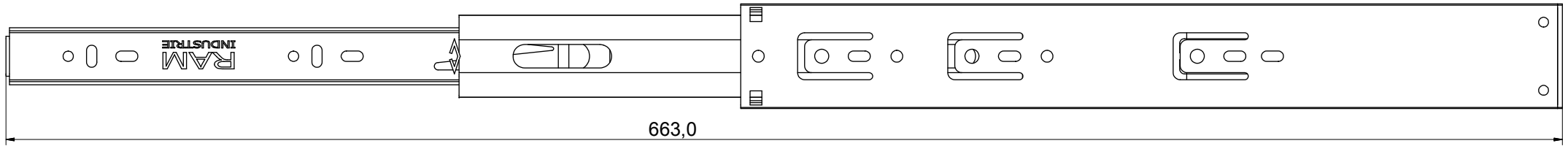

ELENCO PARTI

ELEMENTO	QTÀ	NUMERO PARTE
1	1	Ammortizzatore
2	1	Parte esterna
3	1	Mediano
4	1	Parte interna
5	1	GabbiaCuscinetti
7	1	Levetta
8	2	Cuscinetti

DESIGNED BY Assia	CHECKED AND APPROVED BY Loris	DATE 07/03/2024	CODE NE41350
	GENERAL TOLLERANCE SS-ISO-2768-1M	UNIT	SCALE
	DESCRIPTION	MATERIAL Zinc coated steel	
	DEVICES	PAIR WEIGHT	
<small>Property of Ram Industrie without its written authorization, the present drawing shall neither be used for construction anyway, communicated to third parts, not reproduced</small>			