

A-A (1:1)

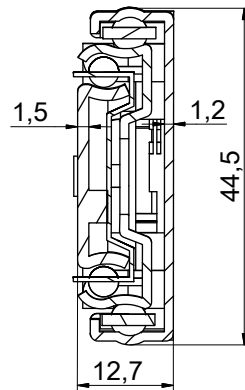

B (1:1)

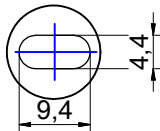

C (1:1)

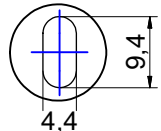

D (1:1)

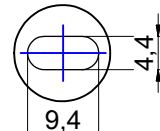

DESIGNED BY Assia	CHECKED AND APPROVED BY Loris	DATE 07/03/2024	CODE NE41450
GENERAL TOLERANCE SS-ISO-2768-1M		UNIT	SCALE 1/2
DESCRIPTION		MATERIAL Zinc coated steel	
DEVICES		PAIR WEIGHT	

Property of Ram Industrie
without its written authorization, the present drawing shall neither
be used for construction anyway, communicated to third parts, not reproduced

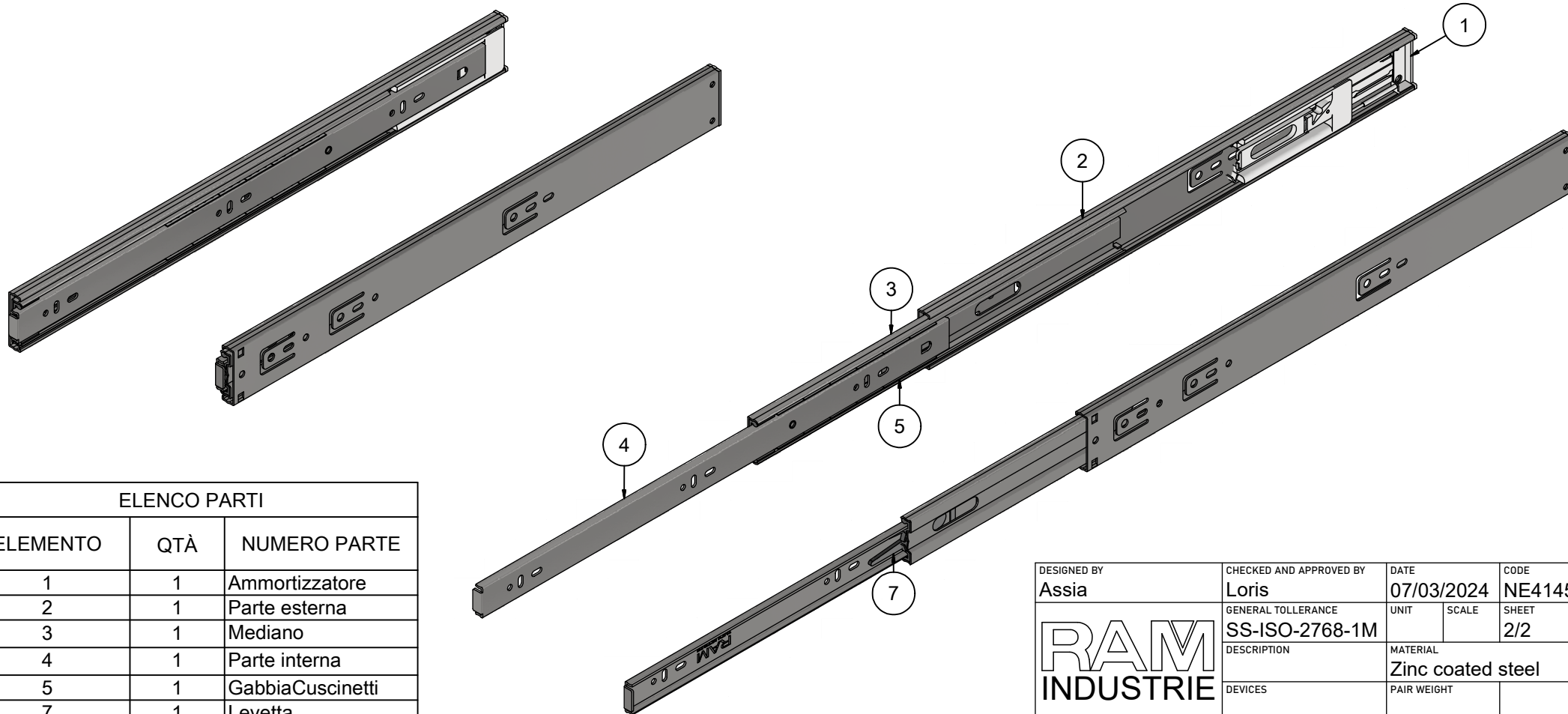
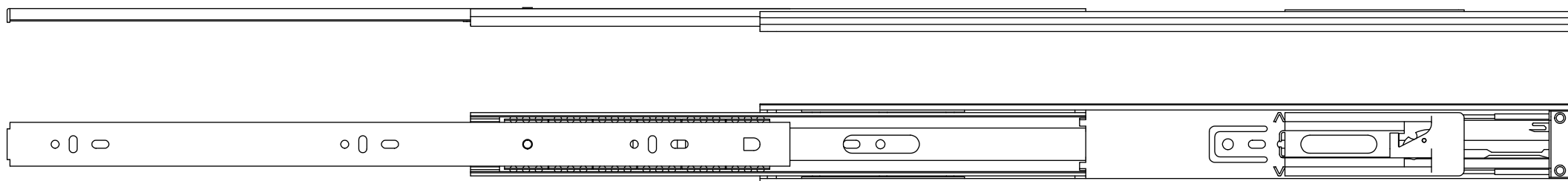
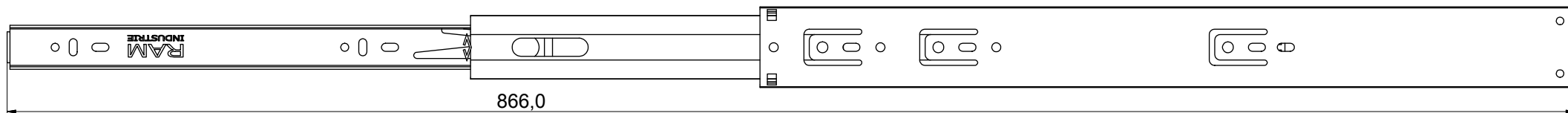

ELENCO PARTI

ELEMENTO	QTÀ	NUMERO PARTE
1	1	Ammortizzatore
2	1	Parte esterna
3	1	Mediano
4	1	Parte interna
5	1	GabbiaCuscinetti
7	1	Levetta
8	2	Cuscinetti

DESIGNED BY Assia	CHECKED AND APPROVED BY Loris	DATE 07/03/2024	CODE NE41450
		GENERAL TOLLERANCE SS-ISO-2768-1M	UNIT SCALE SHEET 2/2
		DESCRIPTION DEVICES	MATERIAL Zinc coated steel PAIR WEIGHT
<small>Property of Ram Industrie without its written authorization, the present drawing shall neither be used for construction anyway, communicated to third parts, not reproduced</small>			