

A-A (1:1)

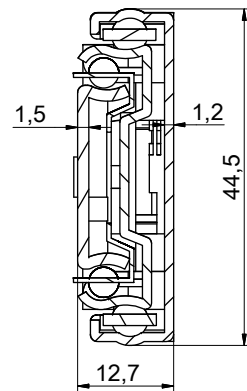

B (1:1)

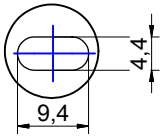

C (1:1)

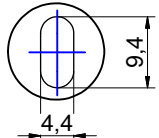

D (1:1)

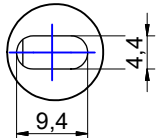

DESIGNED BY Assia	CHECKED AND APPROVED BY Loris	DATE 07/03/2024	CODE NE41500
GENERAL TOLERANCE SS-ISO-2768-1M		UNIT	SCALE 1/2
DESCRIPTION		MATERIAL Zinc coated steel	
DEVICES		PAIR WEIGHT	



Property of Ram Industrie
without its written authorization, the present drawing shall neither
be used for construction anyway, communicated to third parts, not reproduced

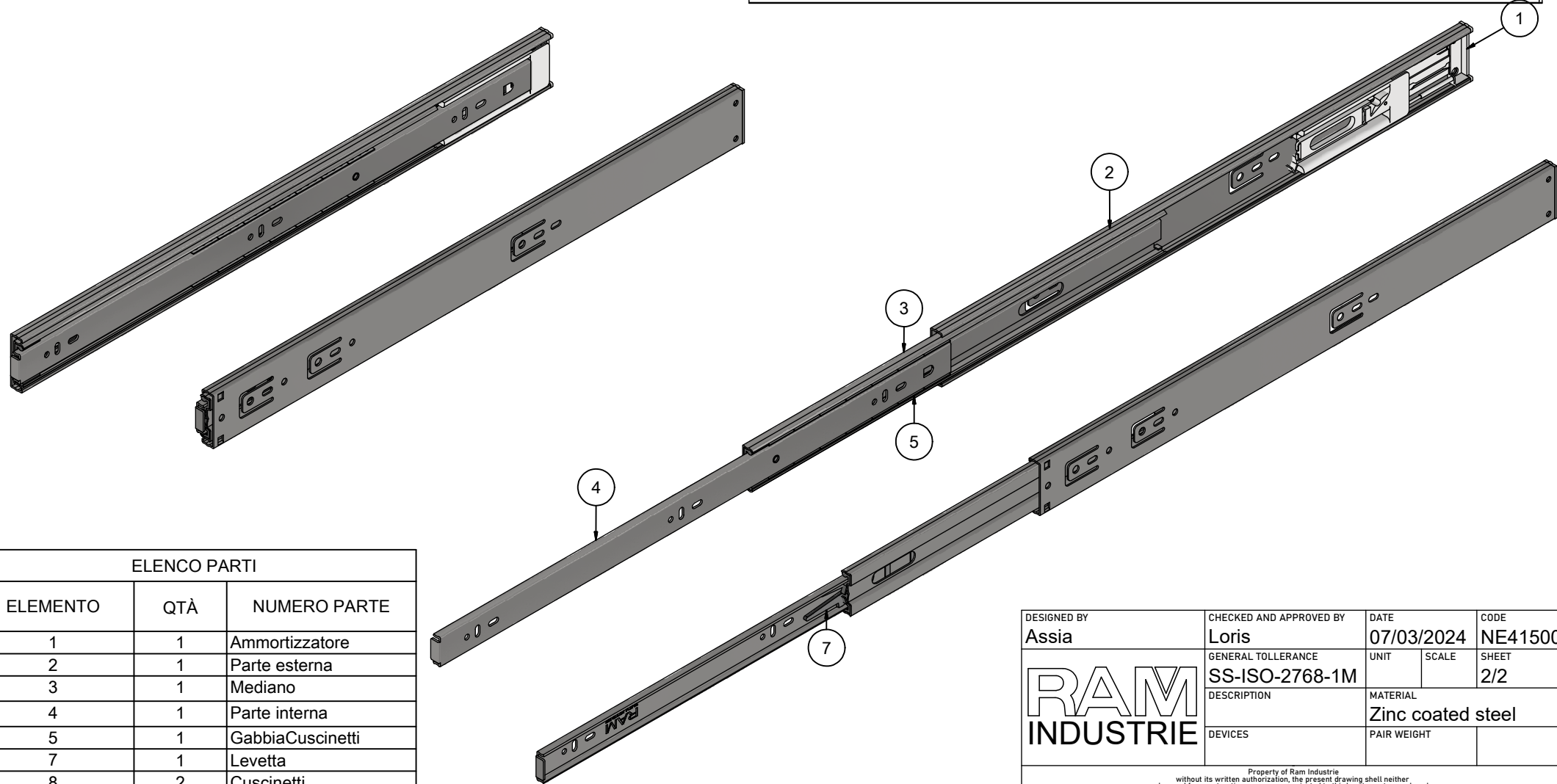
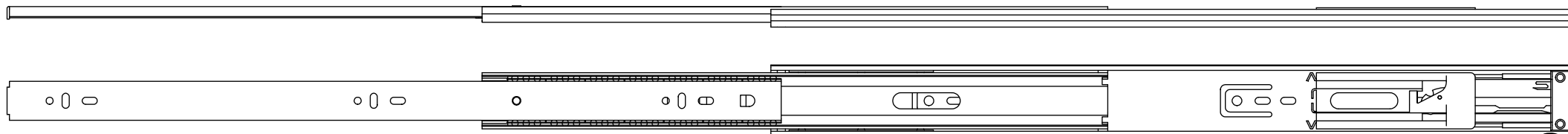
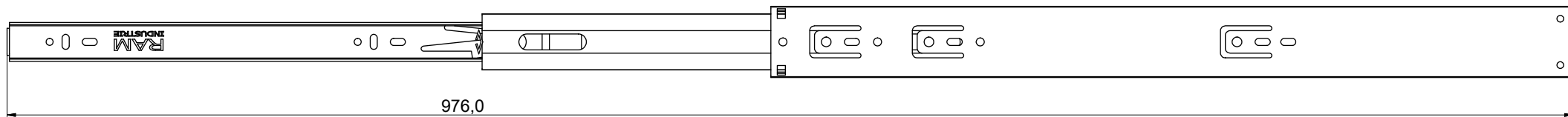

ELENCO PARTI

ELEMENTO	QTÀ	NUMERO PARTE
1	1	Ammortizzatore
2	1	Parte esterna
3	1	Mediano
4	1	Parte interna
5	1	GabbiaCuscinetti
7	1	Levetta
8	2	Cuscinetti

DESIGNED BY Assia	CHECKED AND APPROVED BY Loris	DATE 07/03/2024	CODE NE41500
		GENERAL TOLLERANCE SS-ISO-2768-1M	UNIT SCALE SHEET 2/2
		DESCRIPTION	MATERIAL Zinc coated steel
DEVICES		PAIR WEIGHT	

Property of Ram Industrie
without its written authorization, the present drawing shall neither
be used for construction anyway, communicated to third parts, not reproduced