

SEZ. A-A

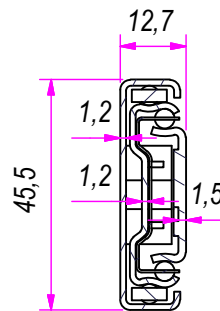

B (1:1)

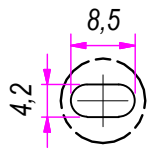

C (1:1)

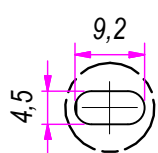

DESIGNED BY F.Dino	CHECKED AND APPROVED BY L. Paleari	REVISION	DATE 15/06/2016	CODE NE48600
GENERAL TOLLERANCE SS-ISO-2768-1M			UNIT mm	SCALE 1 of 2
DESCRIPTION Black finishing (cataphoresis coating)			MATERIAL Cold rolled steel	
DEVICE			PAIR WEIGHT 1,866 Kg	02C

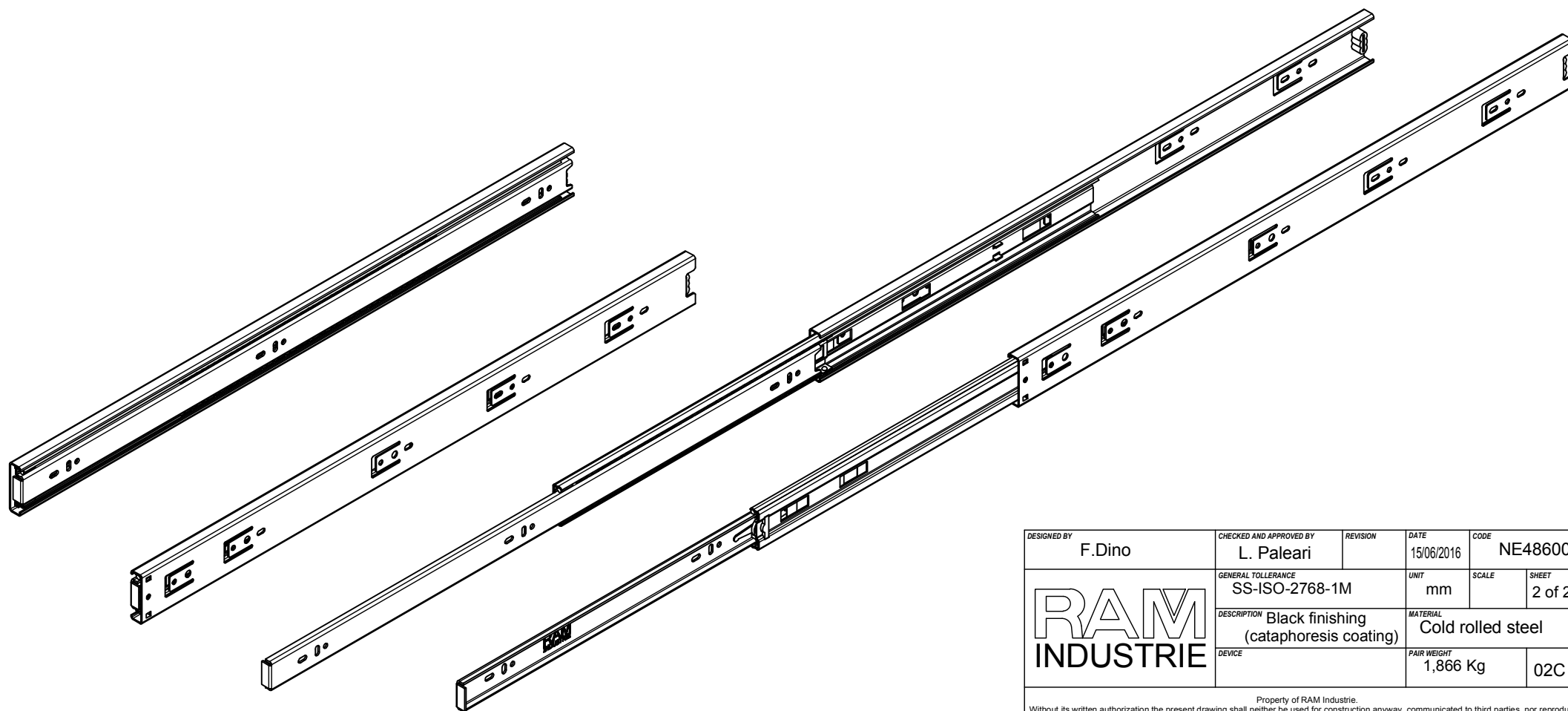
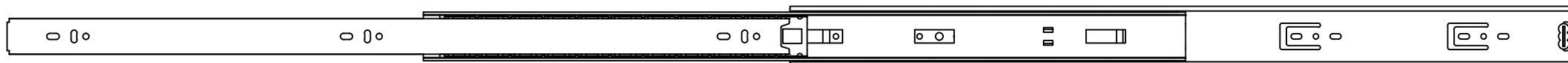
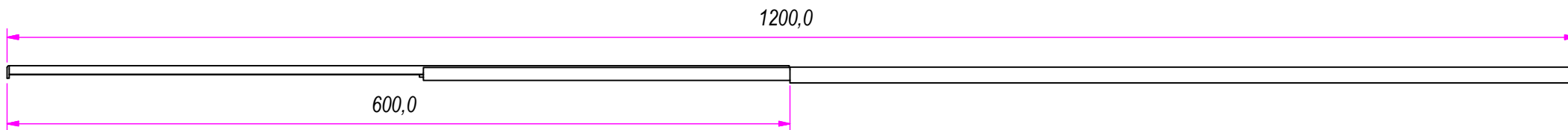
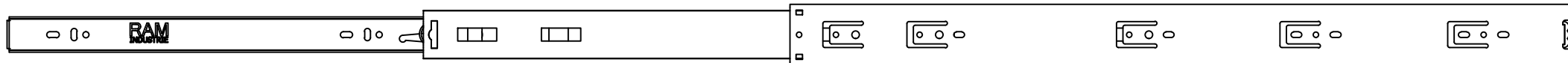

DESIGNED BY F.Dino	CHECKED AND APPROVED BY L. Paleari	REVISION	DATE 15/06/2016	CODE NE48600
		GENERAL TOLLERANCE SS-ISO-2768-1M	UNIT mm	SCALE SHEET 2 of 2
		DESCRIPTION Black finishing (cataphoresis coating)	MATERIAL Cold rolled steel	PAIR WEIGHT 1,866 Kg
DEVICE		1,866 Kg		02C

Property of RAM Industrie.
Without its written authorization the present drawing shall neither be used for construction anyway, communicated to third parties, nor reproduced.