

SEZ. A-A

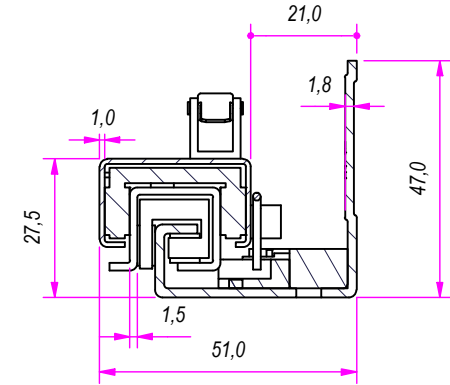

B (1 : 1.5)

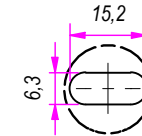

C (1 : 1.5)

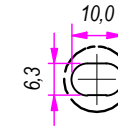

DESIGNED BY F. Dino	CHECKED AND APPROVED BY L. Paleari	GENERAL TOLLERANCE SS-ISO-2768-1M	DATE 16/07/2018	CODE Q23300
PACKAGING Carton 10 sets/Packed R+L			UNIT mm	SHEET 1 of 3
DESCRIPTION Soft self closing/ Oil piston/Push&Rebound		MATERIAL Cold rolled steel	04C	
PAIR WEIGHT 1,504 Kg		PAIR WEIGHT WITH CARTON 1,575 Kg		

RAM
INDUSTRIE

REVISION HISTORY		REV	DESCRIPTION	DATE
Guide per cassetti; guide telescopiche	Coulisses à billes; coulisse télescopique	1a		16/07/2018
Drawer slide; telescopic ball bearing slide	Guías para cajones; guía teleópica			
Kugelführung; Teleskopschienen				

Property of RAM Industrie.
Without its written authorization the present drawing shall neither be used for construction anyway, communicated to third parties, nor reproduced.

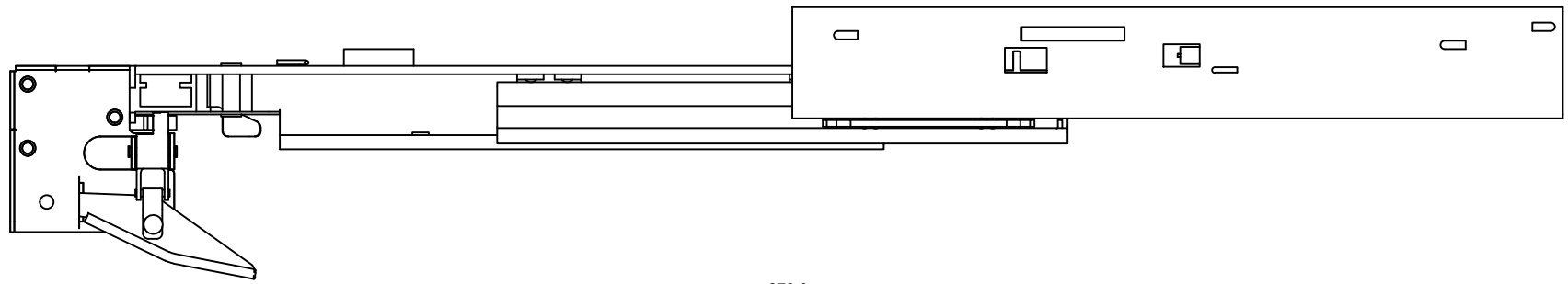

872,0

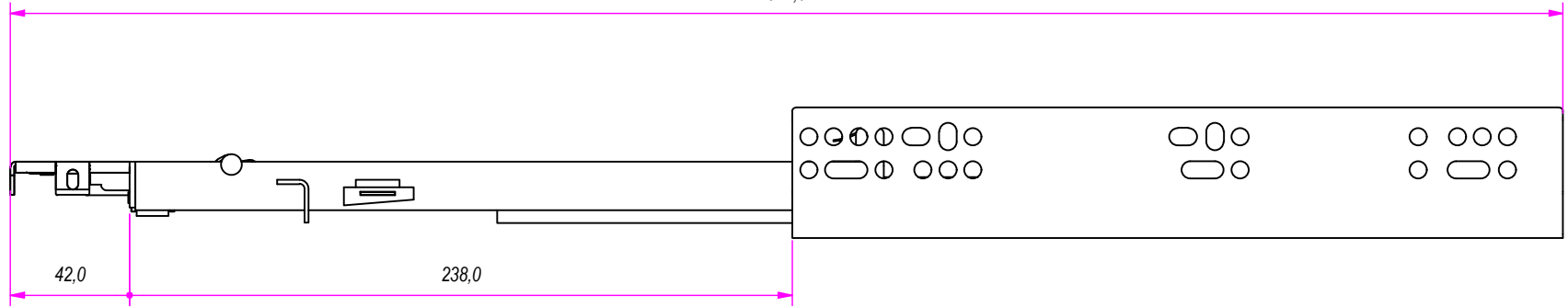

42,0

238,0

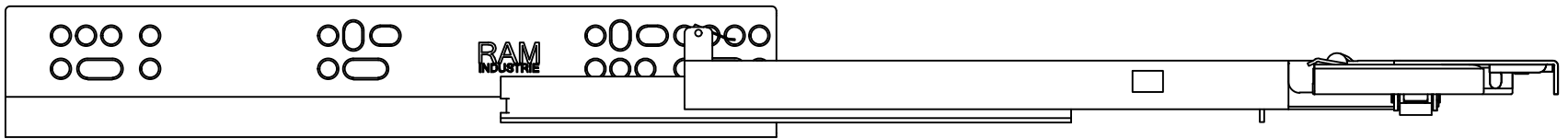
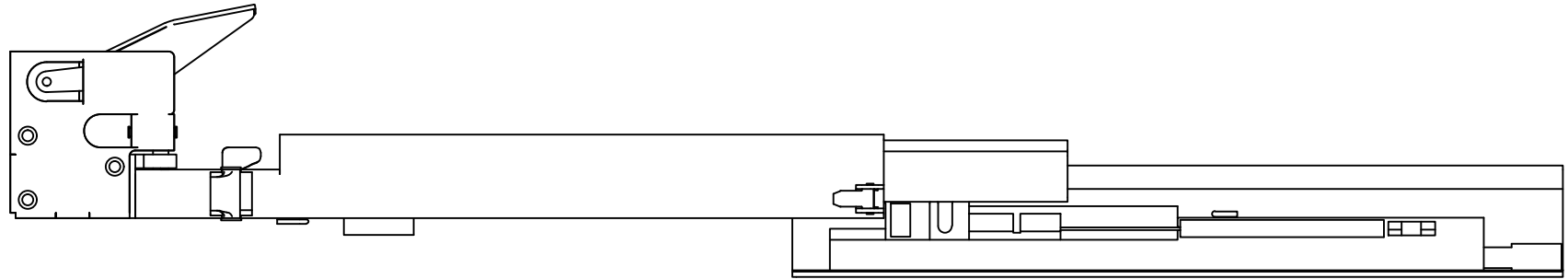



DESIGNED BY F.Dino	CHECKED AND APPROVED BY L. Paleari	GENERAL TOLLERANCE SS-ISO-2768-1M	DATE 16/07/2018	CODE Q23300
PACKAGING Carton 10 sets/Packed R+L			UNIT mm	SHEET 2 of 3
DESCRIPTION Soft self closing/ Oil piston/Push&Rebound			MATERIAL Cold rolled steel	04C
PAIR WEIGHT 1,504 Kg			PAIR WEIGHT WITH CARTON 1,575 Kg	

RAM
INDUSTRIE

REVISION HISTORY		REV	DESCRIPTION	DATE
Guide per cassetti; guide telescopiche	Coulisses à billes; coulisse télescopique	1a		16/07/2018
Drawer slide; telescopic ball bearing slide	Guías para cajones; guía teleópica			
Kugelführung; Teleskopschienen				

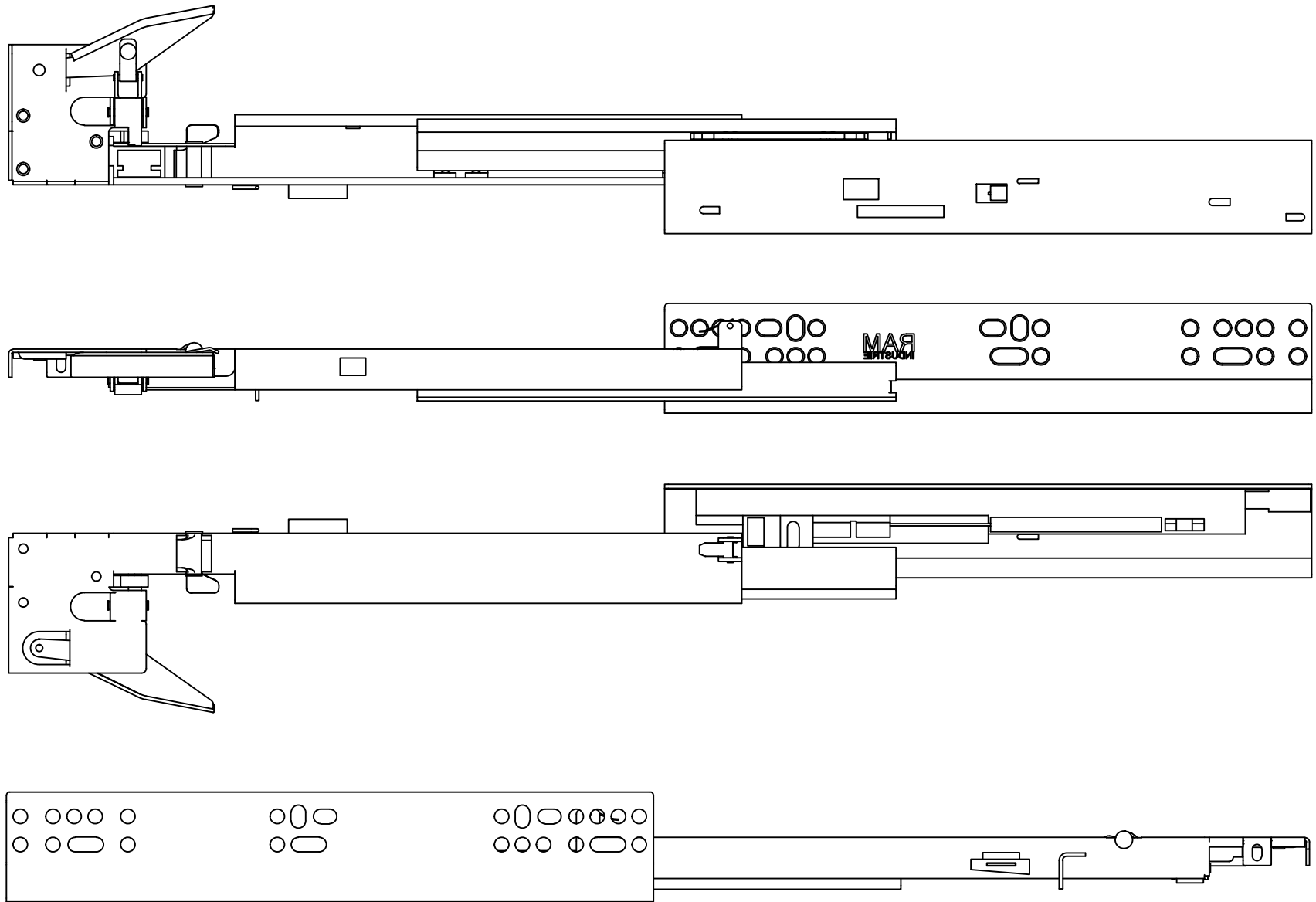
Property of RAM Industrie.
Without its written authorization the present drawing shall neither be used for construction anyway, communicated to third parties, nor reproduced.



DESIGNED BY F.Dino	CHECKED AND APPROVED BY L. Paleari	GENERAL TOLERANCE SS-ISO-2768-1M	DATE 16/07/2018	CODE Q23300
		PACKAGING Carton 10 sets/Packed R+L	UNIT mm	SHEET 3 of 3
		DESCRIPTION	MATERIAL Cold rolled steel 04C	
DEVICE Soft self closing/ Oil piston/Push&Rebound		PAIR WEIGHT 1,504 Kg	PAIR WEIGHT WITH CARTON 1,575 Kg	

Property of RAM Industrie.
Without its written authorization the present drawing shall neither be used for construction anyway, communicated to third parties, nor reproduced.