

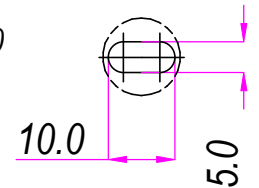

(1:3)
FORO B

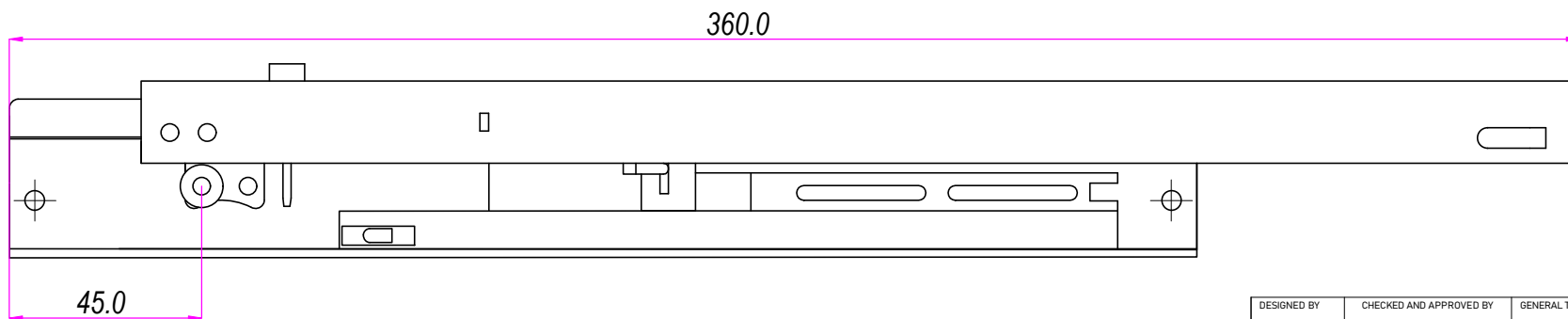

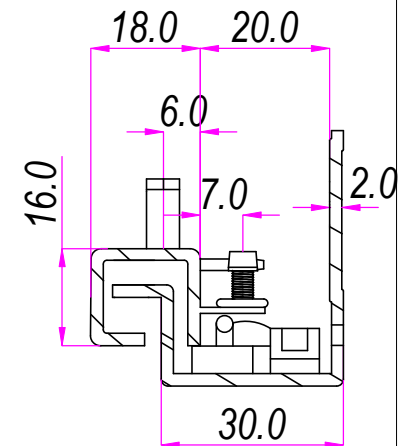

(1:3)
SEZ AA'

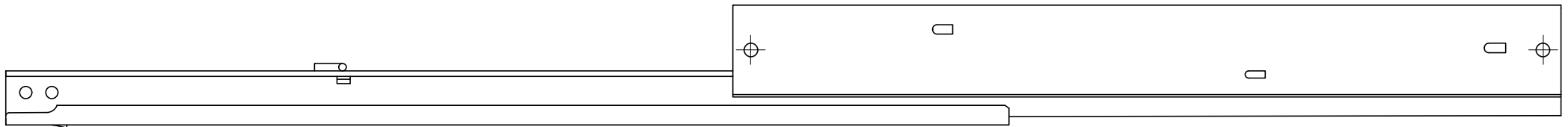
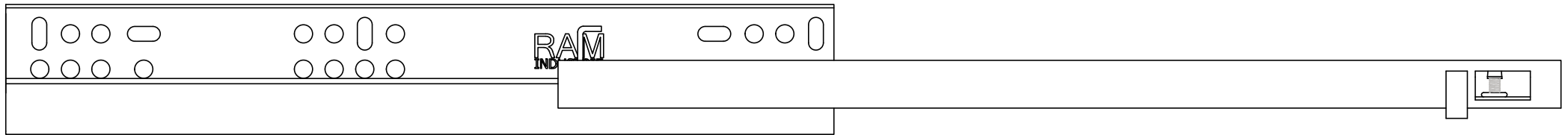
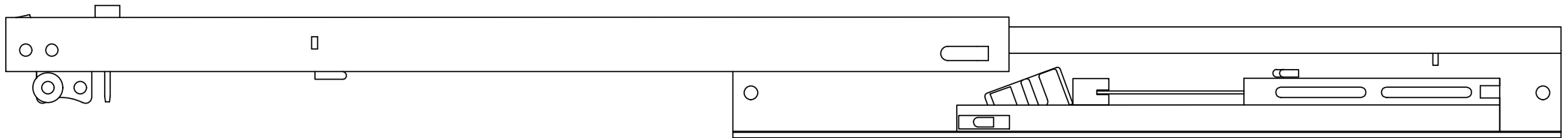
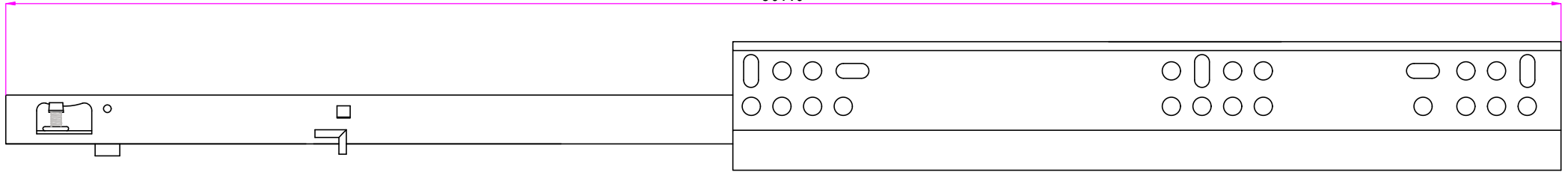

DESIGNED BY A. d'Alesio	CHECKED AND APPROVED BY T. Grassi	GENERAL TOLLERANCE SS-ISO-2768-1M	DATE 22/03/2023	CODE Q40350
PACKAGING Carton 1 piece			UNIT mm	SHEET 1 of 1
		MATERIAL Aluminium 6060		
DEVICE		PAIR WEIGHT WITH CARTON 0,9		

507.0



DESIGNED BY A. d'Alesio	CHECKED AND APPROVED BY T. Grassi	GENERAL TOLLERANCE SS-ISO-2768-1M	DATE 22/03/2023	CODE Q40350
		PACKAGING Carton 1 piece	UNIT mm	SHEET 2 of 2
		DESCRIPTION	MATERIAL Aluminium 6060	
		DEVICE	PAIR WEIGHT WITH CARTON 0,9	
<small>Property of RAM industrie Without its written authorization the present drawing shall neither be used for construction anyway, communicated to third parties, nor reproduced.</small>				