

A-A (1:3)

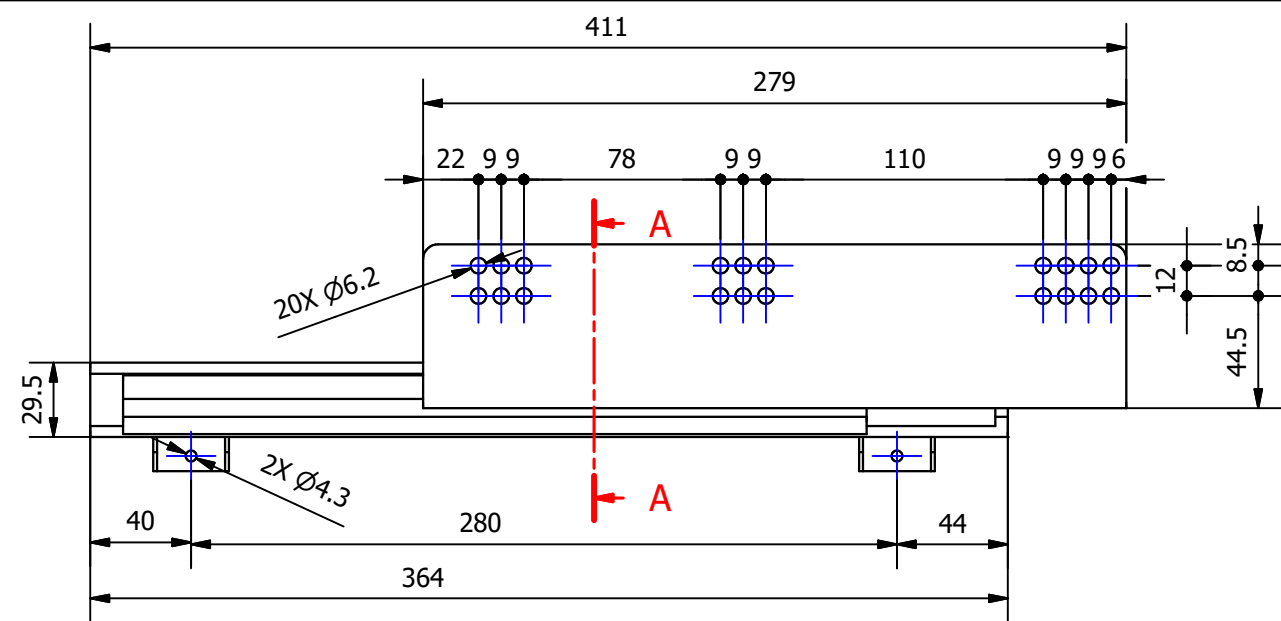

CONFIGURAZIONE
CHIUSA

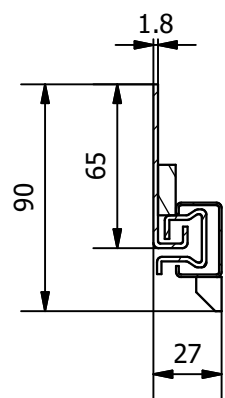
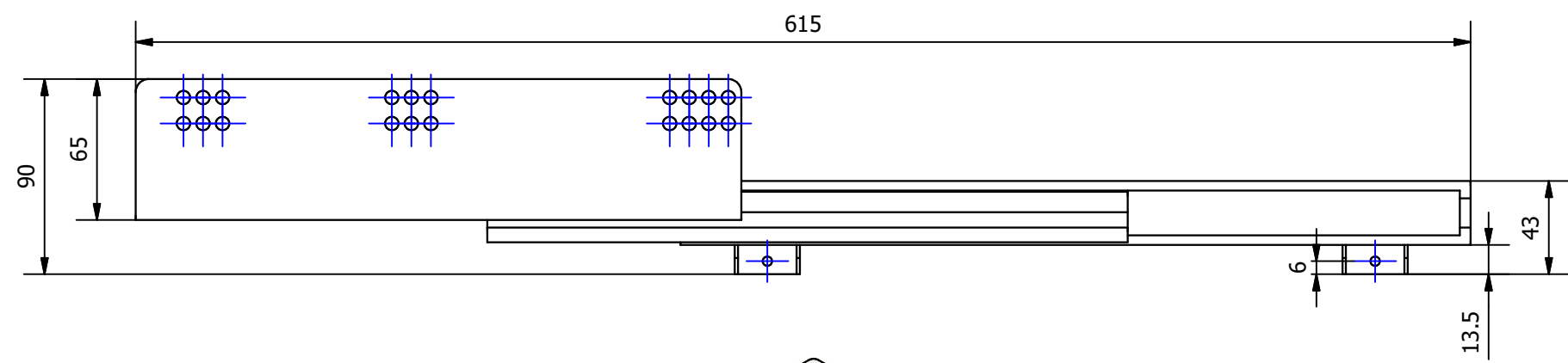

CONFIGURAZIONE
APERTA

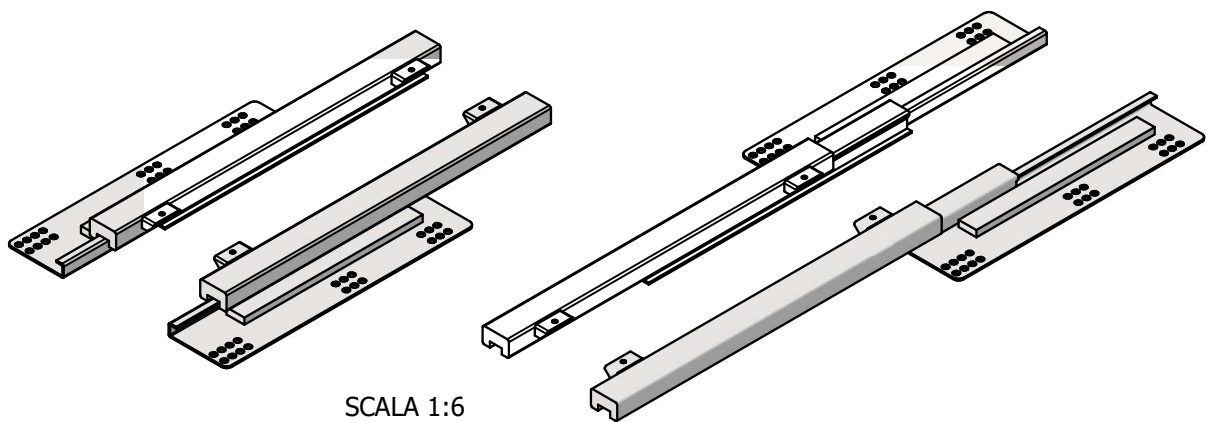

SCALA 1:6

DESIGNED BY Paula	CHECKED AND APPROVED BY Assia	DATE 06/02/2025	CODE Q54400
RAM INDUSTRIE	GENERAL TOLERANCE SS-ISO-2768-1M	UNIT	SCALE 1:3
	DESCRIPTION	MATERIAL	
DEVICES	PAIR WEIGHT		

Property of Ram Industrie
without its written authorization, the present drawing shall neither
be used for construction anyway, communicated to third parts, not reproduced