

C (1 : 3)

REVISION HISTORY		
REV	DESCRIPTION	DATE
1a		29/03/2018

DESIGNED BY F. Dino	CHECKED AND APPROVED BY L. Paleari	GENERAL TOLLERANCE SS-ISO-2768-1M	DATE 28/03/2018	CODE T601000A
PACKAGING Carton 1 piece			UNIT mm	SHEET 1 of 4
DESCRIPTION			MATERIAL Anodise aluminum alloy 6060	
DEVICE			PAIR WEIGHT WITH CARTON 11,5 Kg	

**RAM**  
**INDUSTRIE**

Property of RAM Industrie.

Without its written authorization the present drawing shall neither be used for construction anyway, communicated to third parties, nor reproduced.

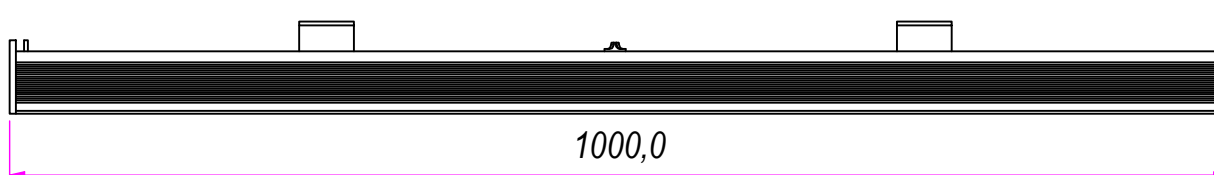
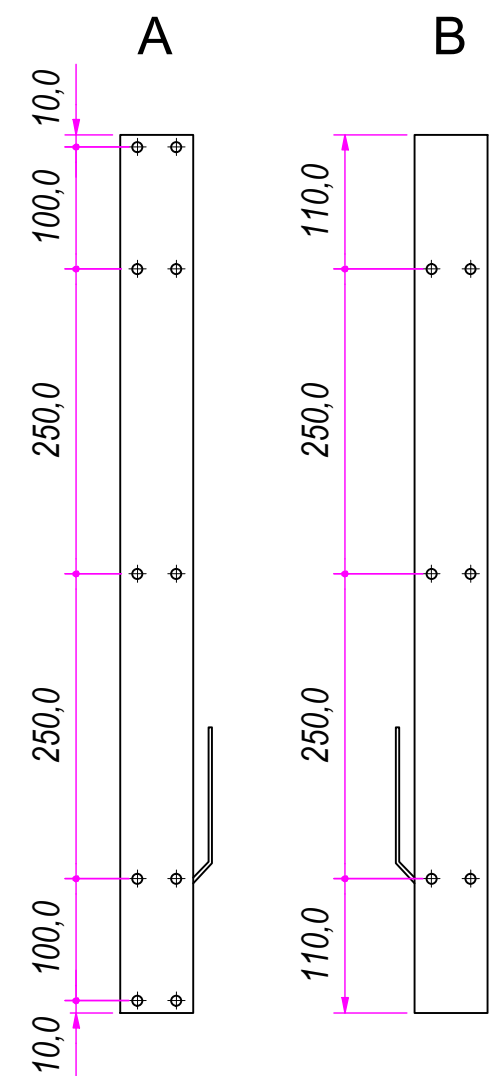
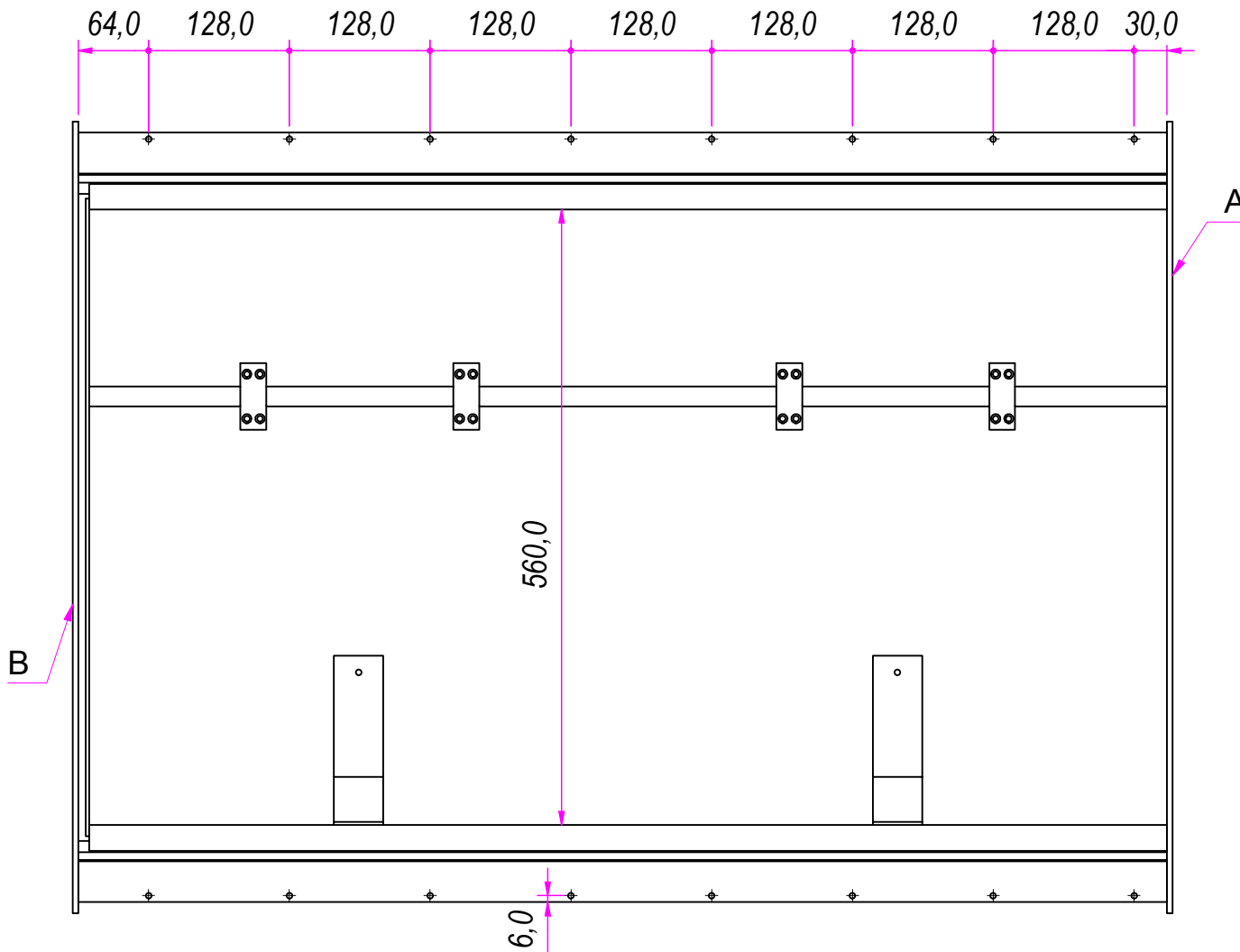

DESIGNED BY F.Dino	CHECKED AND APPROVED BY L. Paleari	GENERAL TOLERANCE SS-ISO-2768-1M	DATE 28/03/2018	CODE T601000A
		PACKAGING Carton 1 piece	UNIT mm	SHEET 2 of 4
		DESCRIPTION	MATERIAL Anodise aluminum alloy 6060	
DEVICE			PAIR WEIGHT WITH CARTON 11,5 Kg	
Property of RAM Industrie. Without its written authorization the present drawing shall neither be used for construction anyway, communicated to third parties, nor reproduced.				

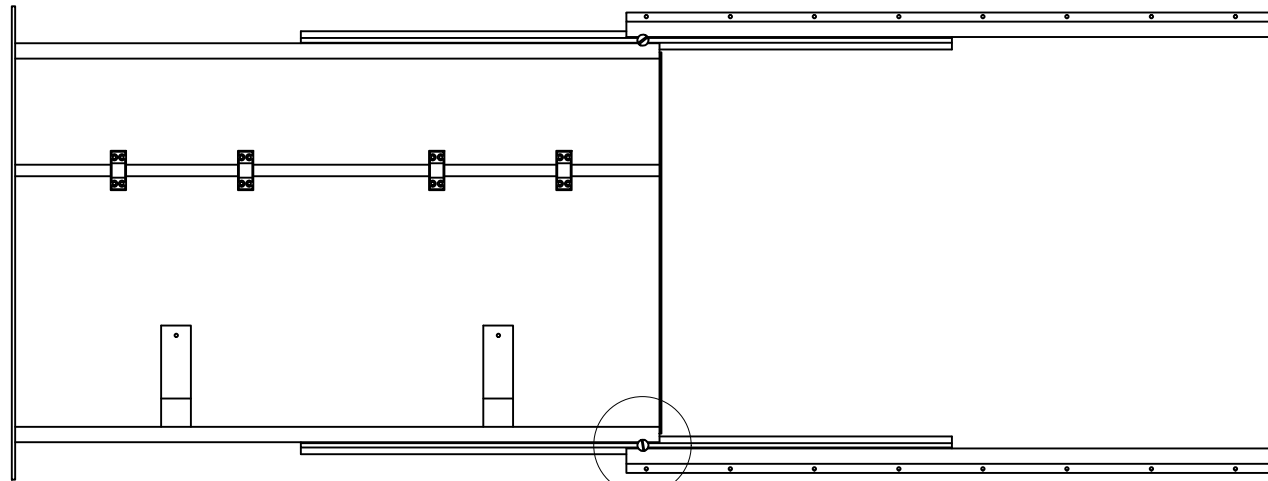

D

1930,0

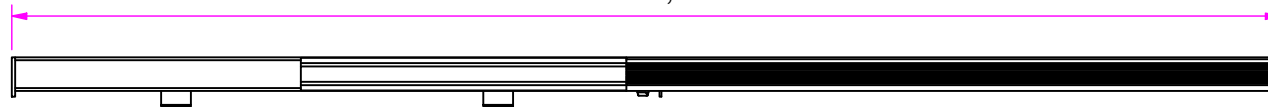

D (1 : 5)

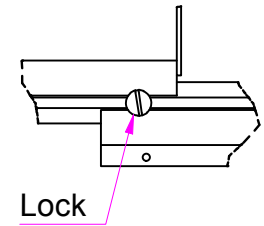

Lock

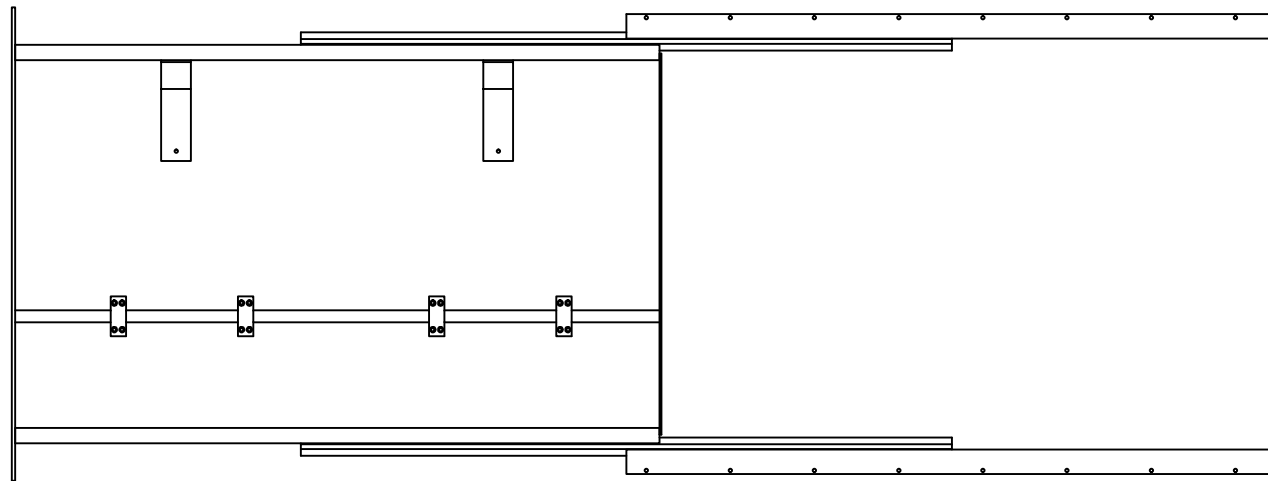

935,0

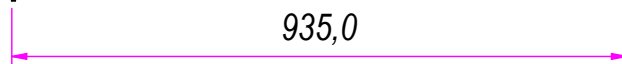

REVISION HISTORY		
REV	DESCRIPTION	DATE
1a		29/03/2018

DESIGNED BY F.Dino	CHECKED AND APPROVED BY L. Paleari	GENERAL TOLERANCE SS-ISO-2768-1M	DATE 28/03/2018	CODE T601000A
PACKAGING Carton 1 piece			UNIT mm	SHEET 3 of 4
DESCRIPTION			MATERIAL Anodise aluminum alloy 6060	
DEVICE			PAIR WEIGHT WITH CARTON 11,5 Kg	

**RAM**  
**INDUSTRIE**

Property of RAM Industrie.

Without its written authorization the present drawing shall neither be used for construction anyway, communicated to third parties, nor reproduced.

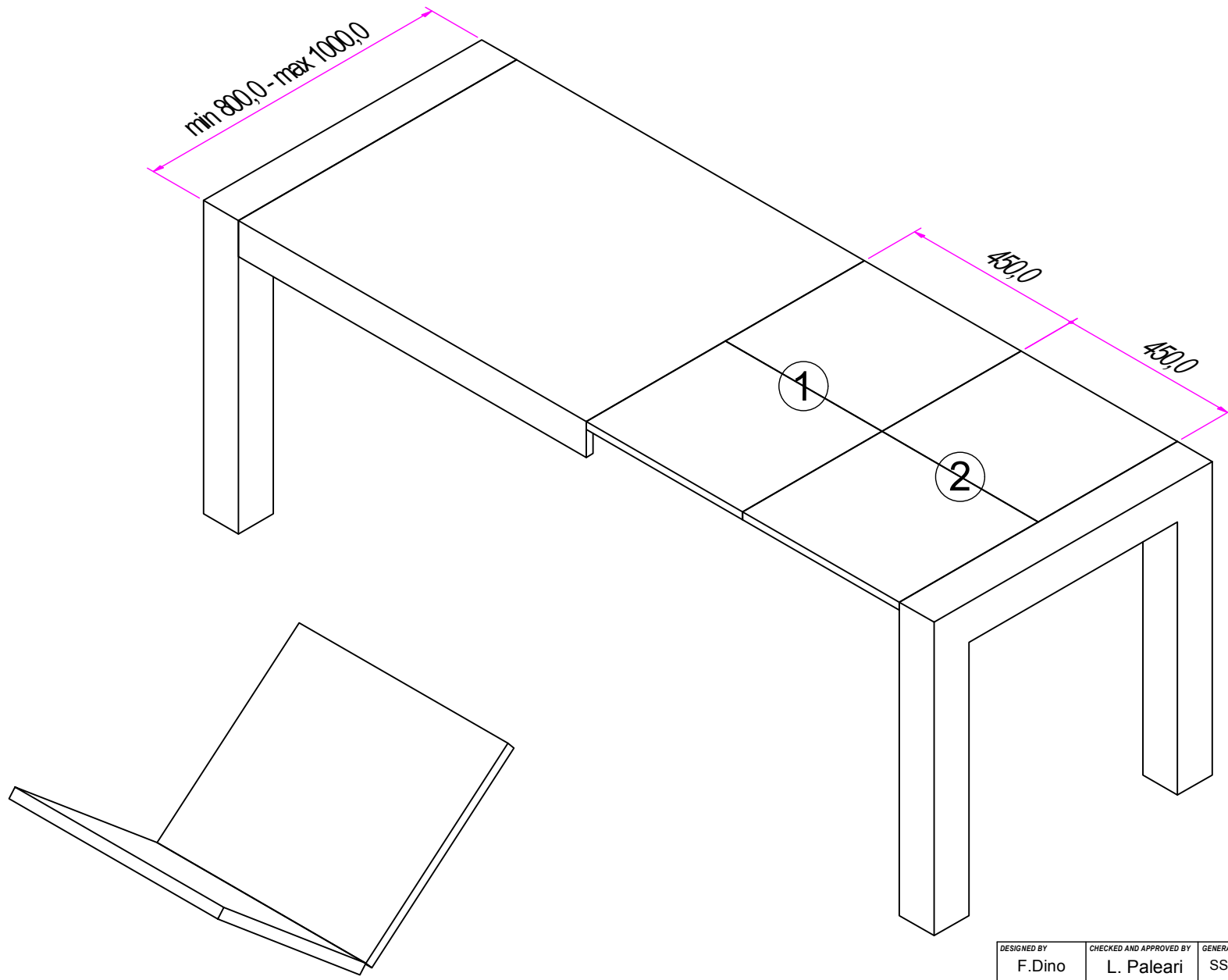

DESIGNED BY F.Dino	CHECKED AND APPROVED BY L. Paleari	GENERAL TOLLERANCE SS-ISO-2768-1M	DATE 28/03/2018	CODE T601000A
		PACKAGING Carton 1 piece	UNIT mm	SHEET 4 of 4
		DESCRIPTION	MATERIAL Anodise aluminum alloy 6060	
DEVICE		PAIR WEIGHT WITH CARTON 11,5 Kg		

Property of RAM Industrie.  
Without its written authorization the present drawing shall neither be used for construction anyway, communicated to third parties, nor reproduced.