

REVISION HISTORY		
REV	DESCRIPTION	DATE
1a		10/10/2018

DESIGNED BY F. Dino	CHECKED AND APPROVED BY L. Paleari	GENERAL TOLERANCE SS-ISO-2768-1M	DATE 10/10/2018	CODE T611200B
PACKAGING Carton 1 piece			UNIT mm	SHEET 1 of 4
DESCRIPTION			MATERIAL Anodise aluminum alloy 6060	
DEVICE			PAIR WEIGHT 10,6 Kg	

RAM
INDUSTRIE

Property of RAM Industrie.
Without its written authorization the present drawing shall neither be used for construction anyway, communicated to third parties, nor reproduced.

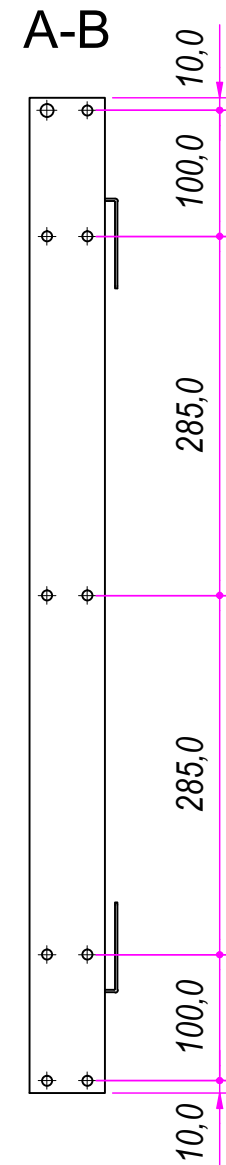
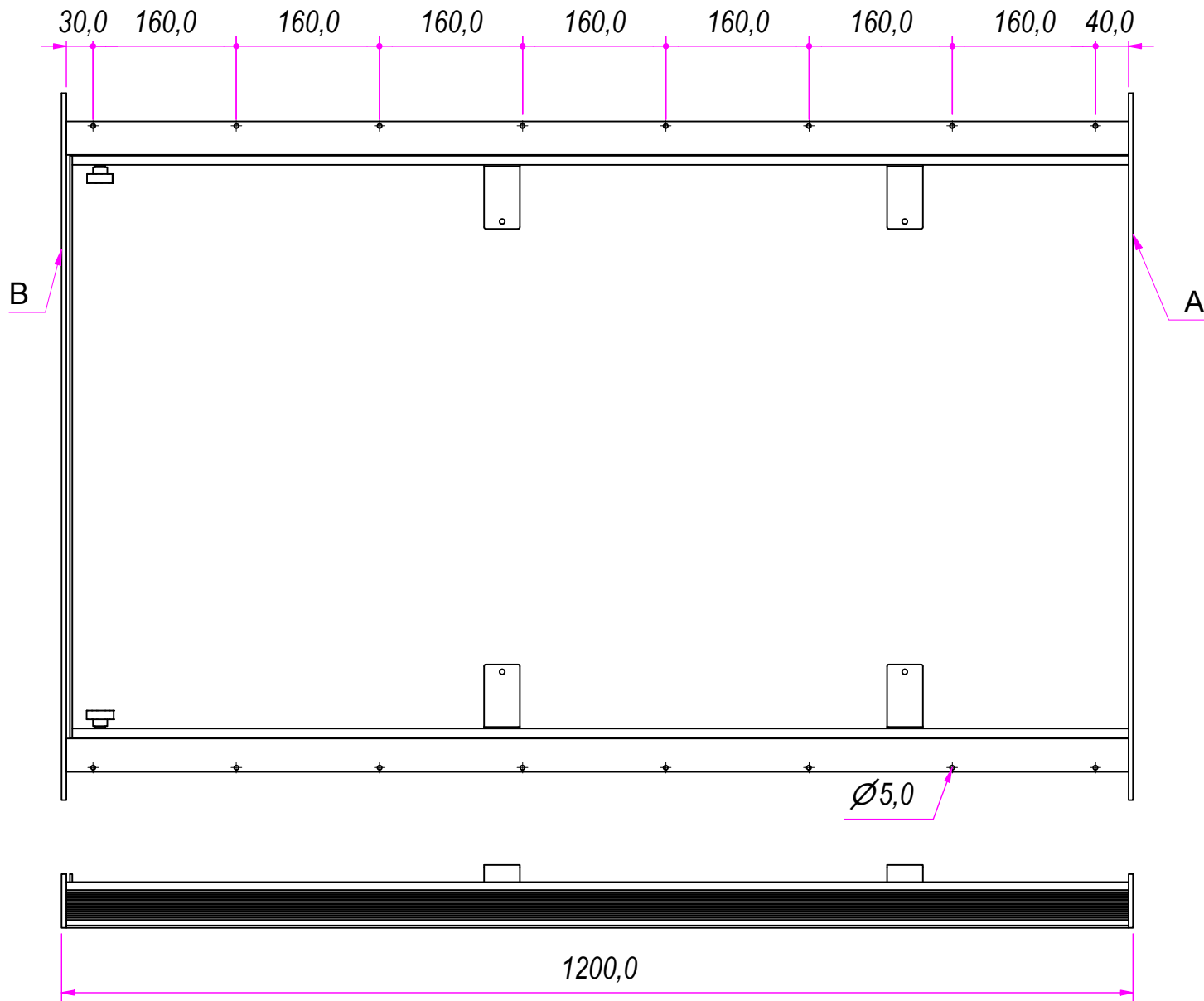

DESIGNED BY F.Dino	CHECKED AND APPROVED BY L. Paleari	GENERAL TOLERANCE SS-ISO-2768-1M	DATE 10/10/2018	CODE T611200B
PACKAGING Carton 1 piece		UNIT mm	SHEET 2 of 4	
DESCRIPTION RAM INDUSTRIE		MATERIAL Anodise aluminum alloy 6060		
DEVICE		PAIR WEIGHT 10,6 Kg		

Property of RAM Industrie.
Without its written authorization the present drawing shall neither be used for construction anyway, communicated to third parties, nor reproduced.

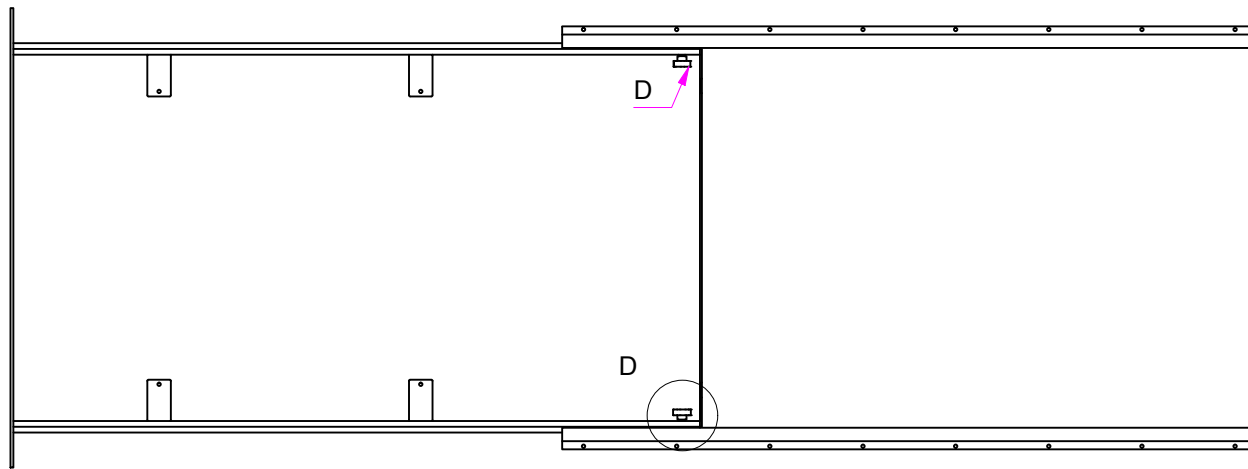

2140,0

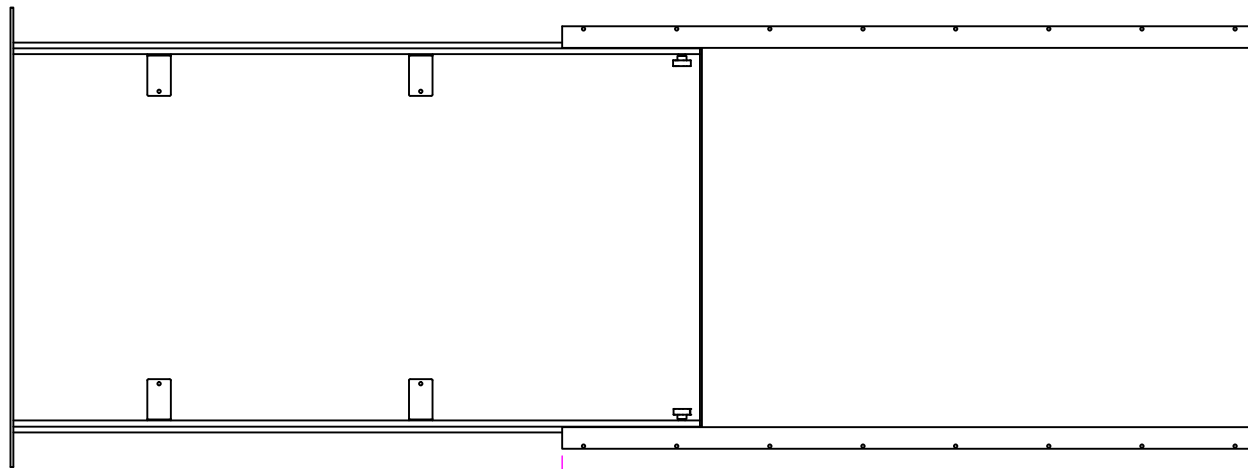
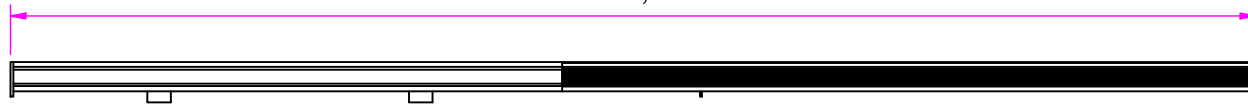

945,0

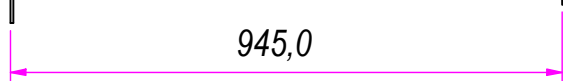

D (1 : 5)

Locking screw knob

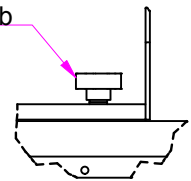



REVISION HISTORY		
REV	DESCRIPTION	DATE
1a		10/10/2018

DESIGNED BY F.Dino	CHECKED AND APPROVED BY L. Paleari	GENERAL TOLLERANCE SS-ISO-2768-1M	DATE 10/10/2018	CODE T611200B
PACKAGING Carton 1 piece			UNIT mm	SHEET 3 of 4
DESCRIPTION			MATERIAL Anodise aluminum alloy 6060	
DEVICE			PAIR WEIGHT 10,6 Kg	

RAM
INDUSTRIE

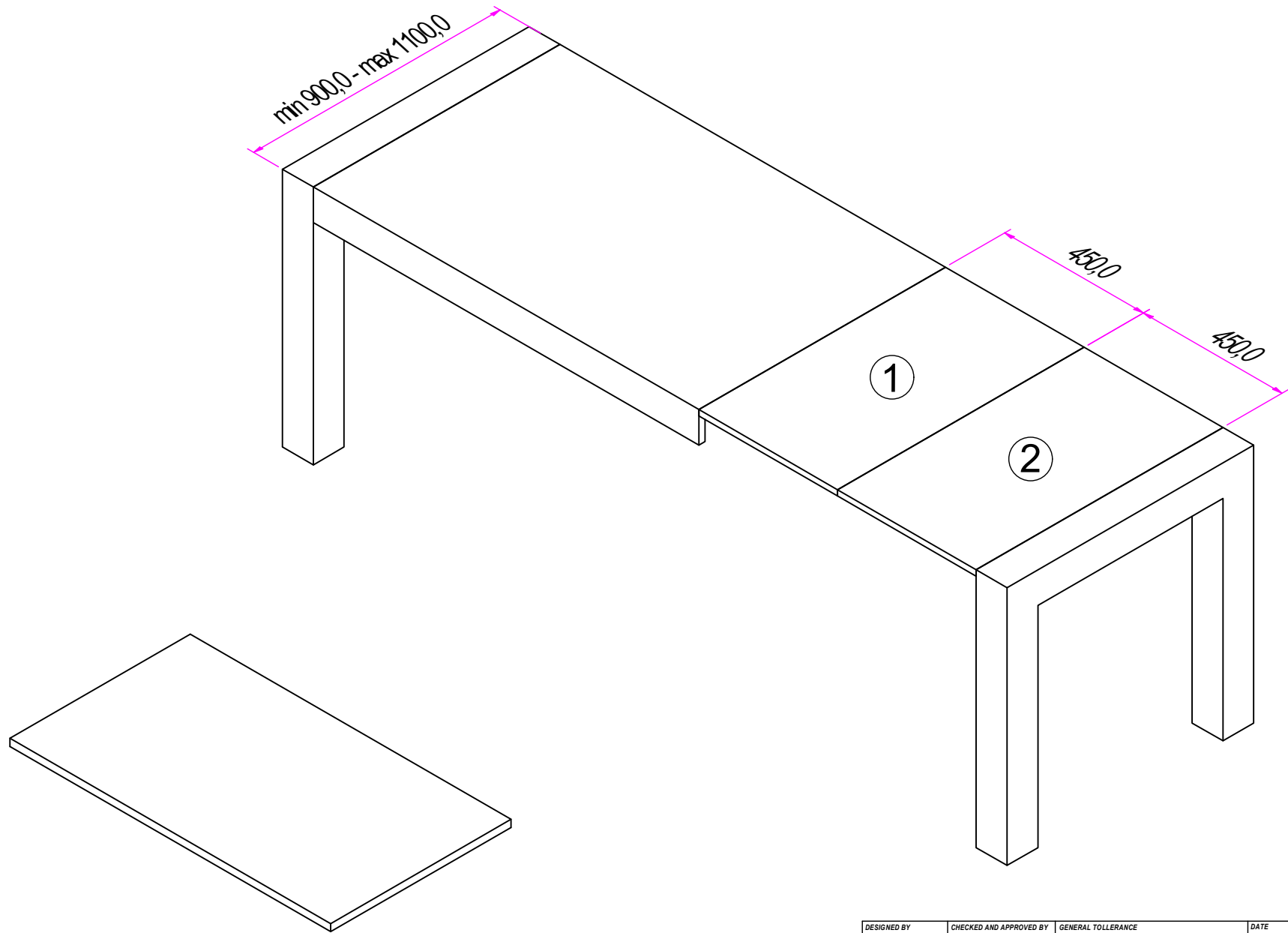
Property of RAM Industrie.
Without its written authorization the present drawing shall neither be used for construction anyway, communicated to third parties, nor reproduced.



DESIGNED BY F.Dino	CHECKED AND APPROVED BY L. Paleari	GENERAL TOLERANCE SS-ISO-2768-1M	DATE 10/10/2018	CODE T611200B
		PACKAGING Carton 1 piece	UNIT mm	SHEET 4 of 4
		DESCRIPTION	MATERIAL Anodise aluminum alloy 6060	
DEVICE			PAIR WEIGHT 10,6 Kg	021

Property of RAM Industrie.
Without its written authorization the present drawing shall neither be used for construction anyway, communicated to third parties, nor reproduced.