

DESIGNED BY F. Dino	CHECKED AND APPROVED BY L. Paleari	GENERAL TOLERANCE SS-ISO-2768-1M	DATE 09/10/2018	CODE T621200A
PACKAGING Carton 1 piece			UNIT mm	SHEET 1 of 4
DESCRIPTION Single extension		MATERIAL Anodise aluminum alloy 6060		
DEVICE			PAIR WEIGHT WITH CARTON 10,1 Kg	021

RAM
INDUSTRIE

REVISION HISTORY		
REV	DESCRIPTION	DATE
1a		10/10/2018

Property of RAM Industrie.
Without its written authorization the present drawing shall neither be used for construction anyway, communicated to third parties, nor reproduced.

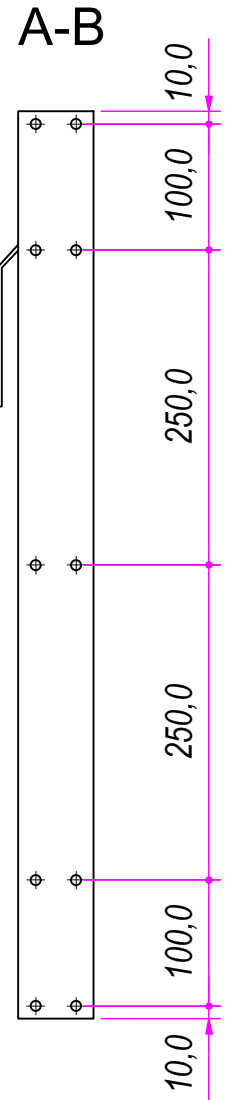
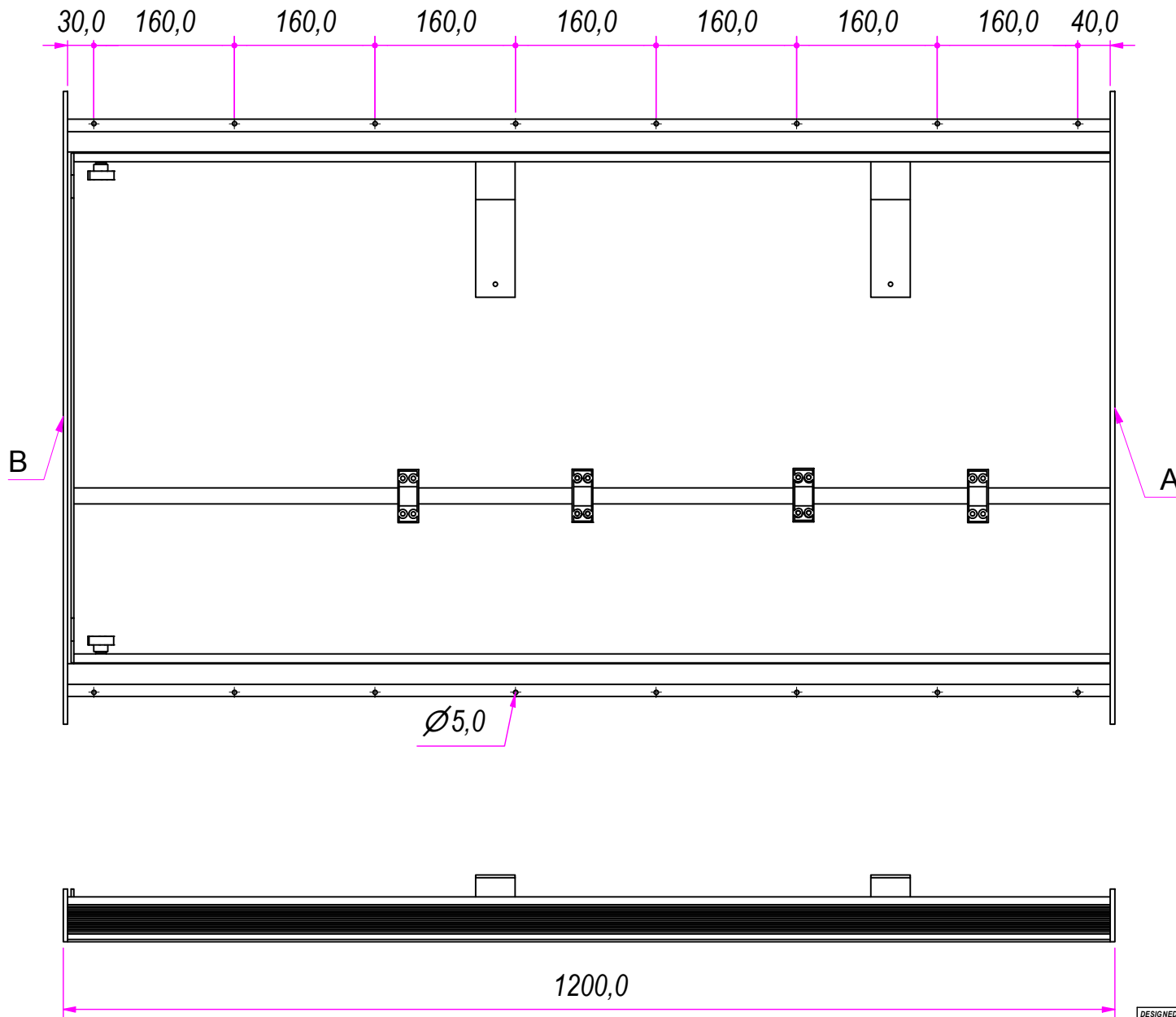

DESIGNED BY F.Dino	CHECKED AND APPROVED BY L. Paleari	GENERAL TOLLERANCE SS-ISO-2768-1M	DATE 09/10/2018	CODE T621200A
PACKAGING Carton 1 piece			UNIT mm	SHEET 2 of 4
DESCRIPTION Single extension		MATERIAL Anodise aluminum alloy 6060		
DEVICE			PAIR WEIGHT WITH CARTON 10,1 Kg	021

RAM
INDUSTRIE

REVISION HISTORY		
REV	DESCRIPTION	DATE
1a		10/10/2018

Property of RAM Industrie.
Without its written authorization the present drawing shall neither be used for construction anyway, communicated to third parties, nor reproduced.

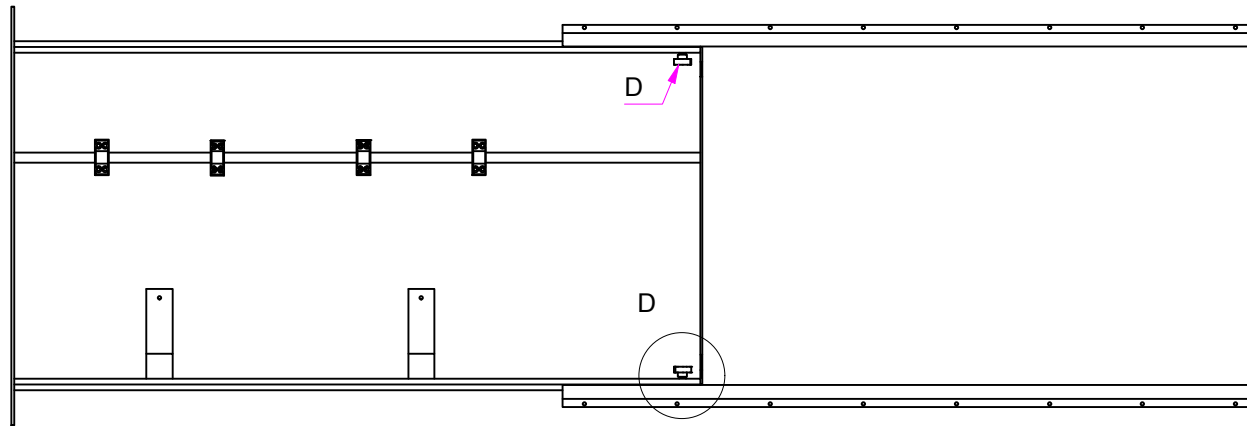

2140,0

D (1 : 5)

Locking screw knob

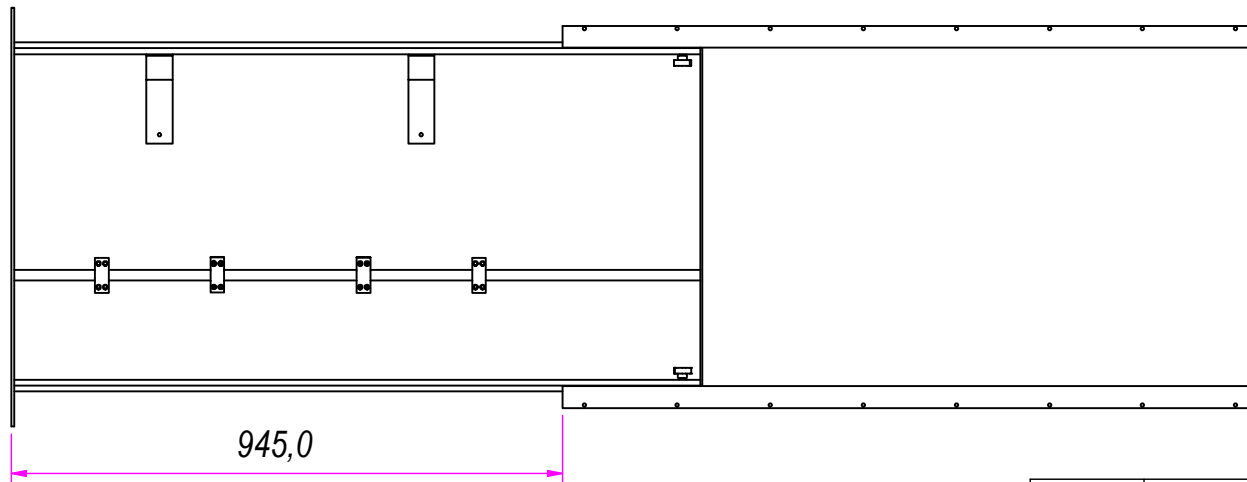
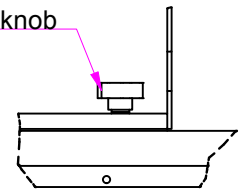



945,0

DESIGNED BY F.Dino	CHECKED AND APPROVED BY L. Paleari	GENERAL TOLERANCE SS-ISO-2768-1M	DATE 09/10/2018	CODE T621200A
		PACKAGING Carton 1 piece	UNIT mm	SHEET 3 of 4
		DESCRIPTION Single extension	MATERIAL Anodise aluminum alloy 6060	
		DEVICE	PAIR WEIGHT WITH CARTON 10,1 Kg	021

REVISION HISTORY		
REV	DESCRIPTION	DATE
1a		10/10/2018

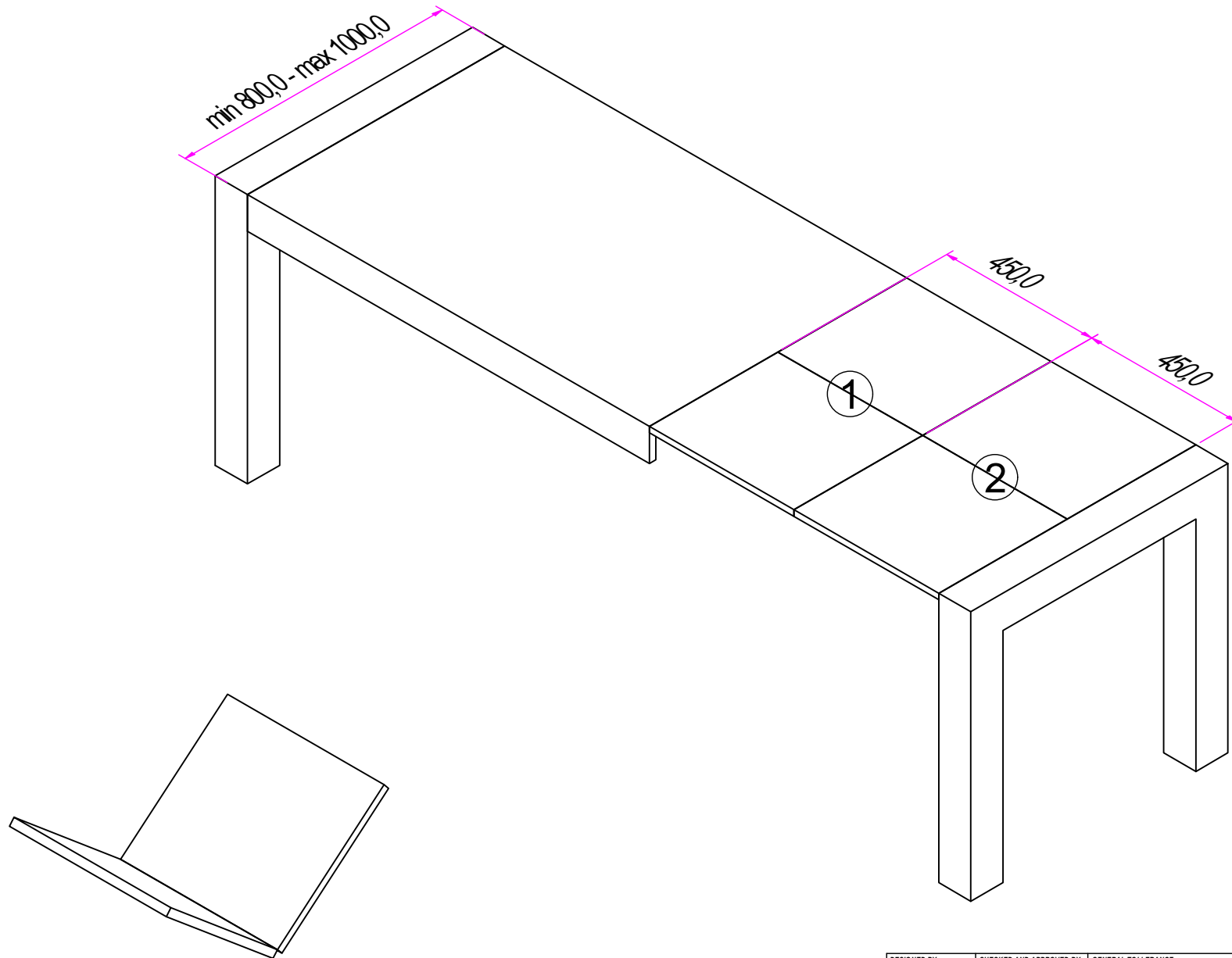
Property of RAM Industrie.
Without its written authorization the present drawing shall neither be used for construction anyway, communicated to third parties, nor reproduced.



DESIGNED BY F.Dino	CHECKED AND APPROVED BY L. Paleari	GENERAL TOLLERANCE SS-ISO-2768-1M	DATE 09/10/2018	CODE T621200A
		PACKAGING Carton 1 piece	UNIT mm	SHEET 4 of 4
		DESCRIPTION Single extension	MATERIAL Anodise aluminum alloy 6060	
DEVICE			PAIR WEIGHT WITH CARTON 10,1 Kg	021

Property of RAM Industrie.
Without its written authorization the present drawing shall neither be used for construction anyway, communicated to third parties, nor reproduced.