

DESIGNED BY F.Dino	CHECKED AND APPROVED BY L. Paleari	GENERAL TOLLERANCE SS-ISO-2768-1M	DATE 10/10/2018	CODE T621300B
PACKAGING Carton 1 piece			UNIT mm	SHEET 1 of 4
DESCRIPTION Single extension		MATERIAL Anodise aluminum alloy 6060		
DEVICE		PAIR WEIGHT 11 Kg		021

RAM
INDUSTRIE

REVISION HISTORY		
REV	DESCRIPTION	DATE
1a		10/10/2018

Property of RAM Industrie.
Without its written authorization the present drawing shall neither be used for construction anyway, communicated to third parties, nor reproduced.

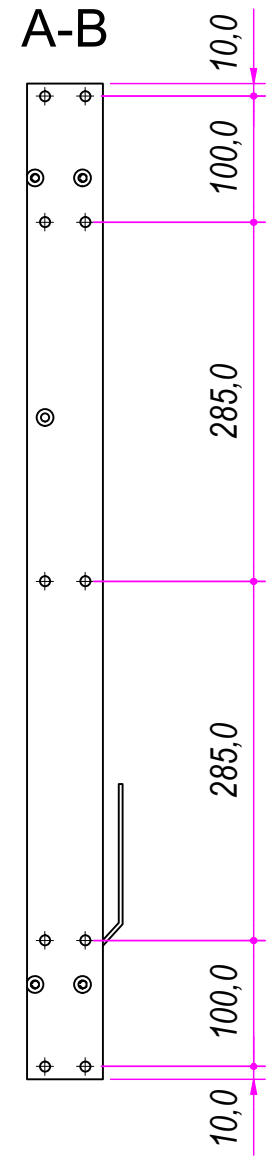
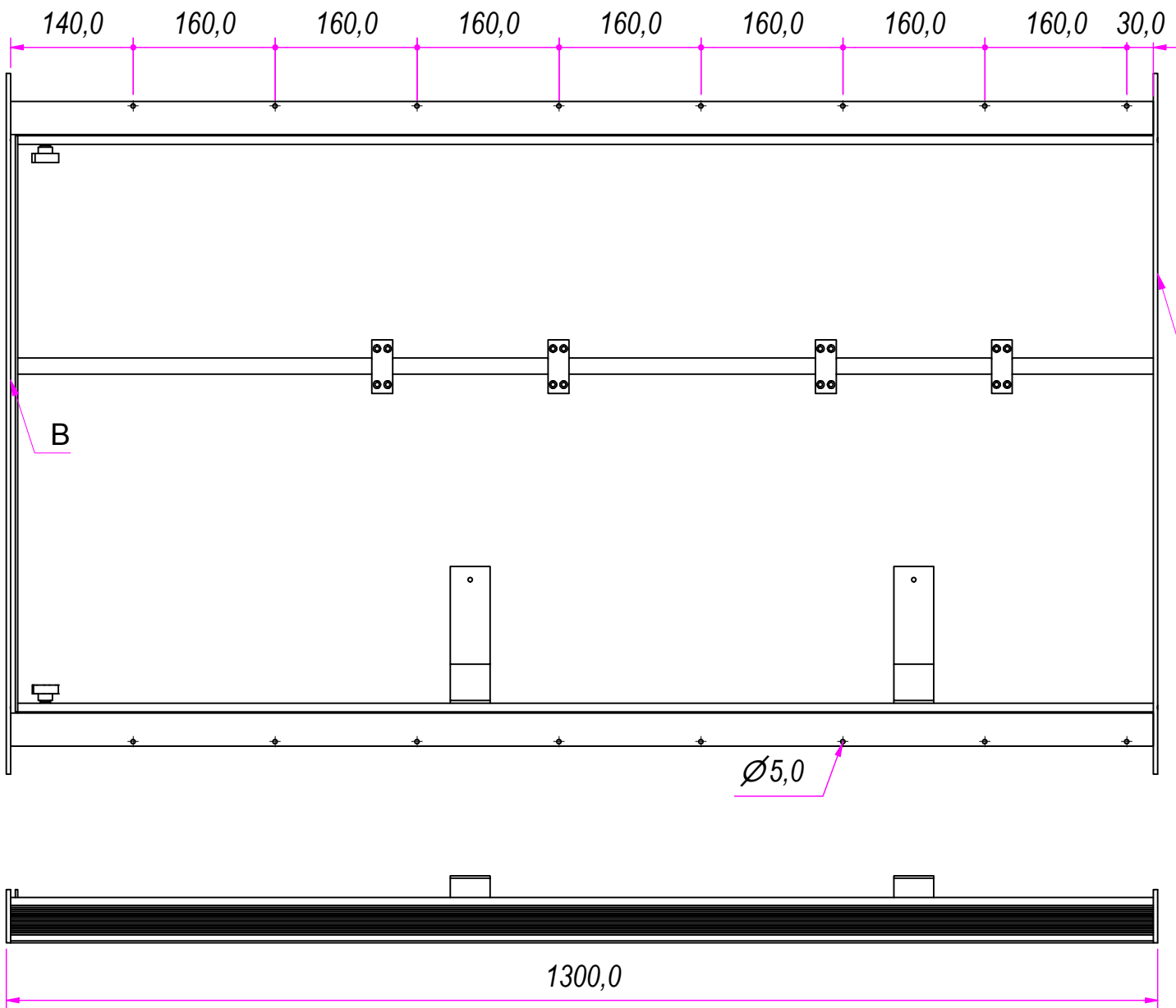

DESIGNED BY F. Dino	CHECKED AND APPROVED BY L. Paleari	GENERAL TOLERANCE SS-ISO-2768-1M	DATE 10/10/2018	CODE T621300B
PACKAGING Carton 1 piece			UNIT mm	SHEET 2 of 4
DESCRIPTION Single extension		MATERIAL Anodise aluminum alloy 6060		
DEVICE			PAIR WEIGHT 11 Kg	021

RAM
INDUSTRIE

Property of RAM Industrie.
Without its written authorization the present drawing shall neither be used for construction anyway, communicated to third parties, nor reproduced.

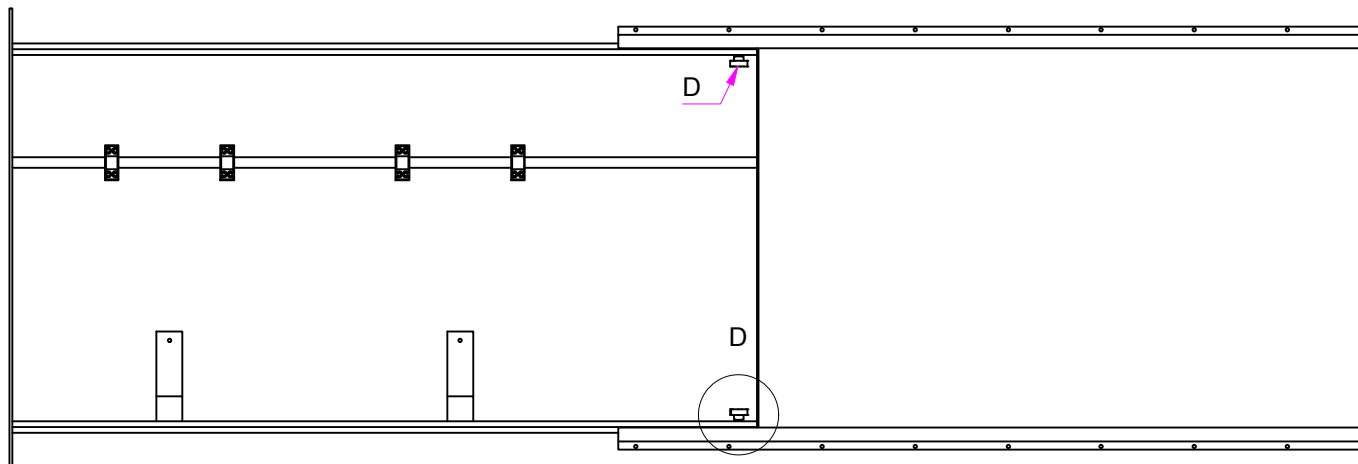

D (1 : 5)

Locking screw knob

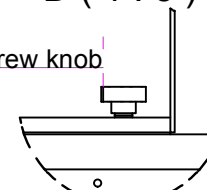

2340,0

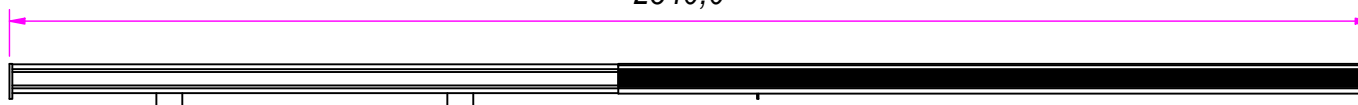

1045,0

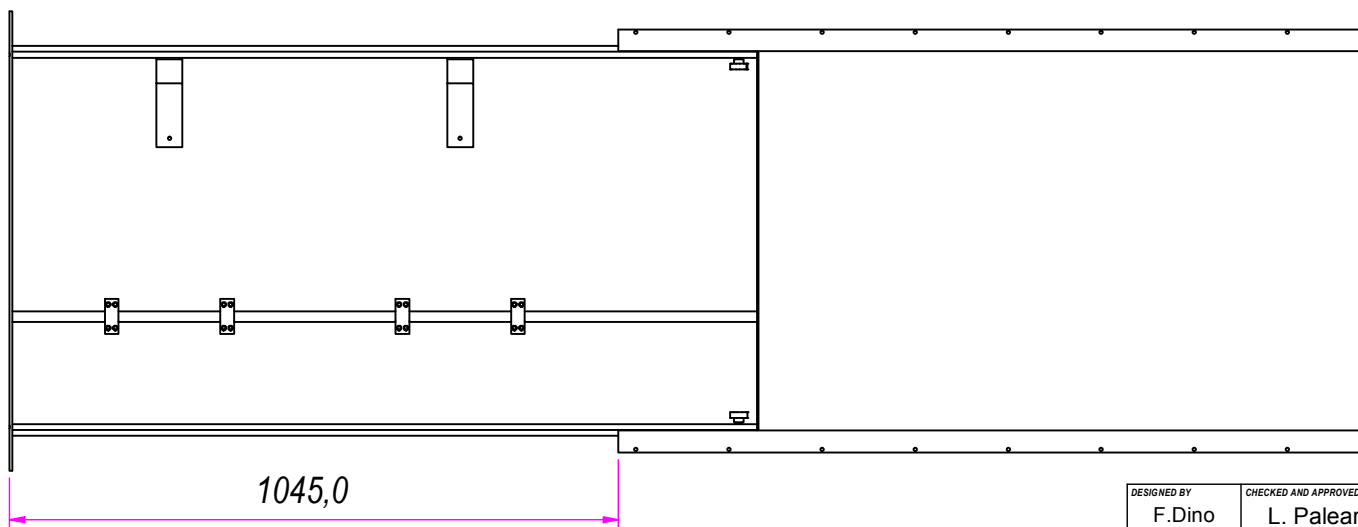

DESIGNED BY F.Dino	CHECKED AND APPROVED BY L. Paleari	GENERAL TOLERANCE SS-ISO-2768-1M	DATE 10/10/2018	CODE T621300B
		PACKAGING Carton 1 piece	UNIT mm	SHEET 3 of 4
		DESCRIPTION Single extension	MATERIAL Anodise aluminum alloy 6060	
DEVICE			PAIR WEIGHT 11 Kg	02l

REVISION HISTORY		
REV	DESCRIPTION	DATE
1a		10/10/2018

Property of RAM Industrie.
Without its written authorization the present drawing shall neither be used for construction anyway, communicated to third parties, nor reproduced.

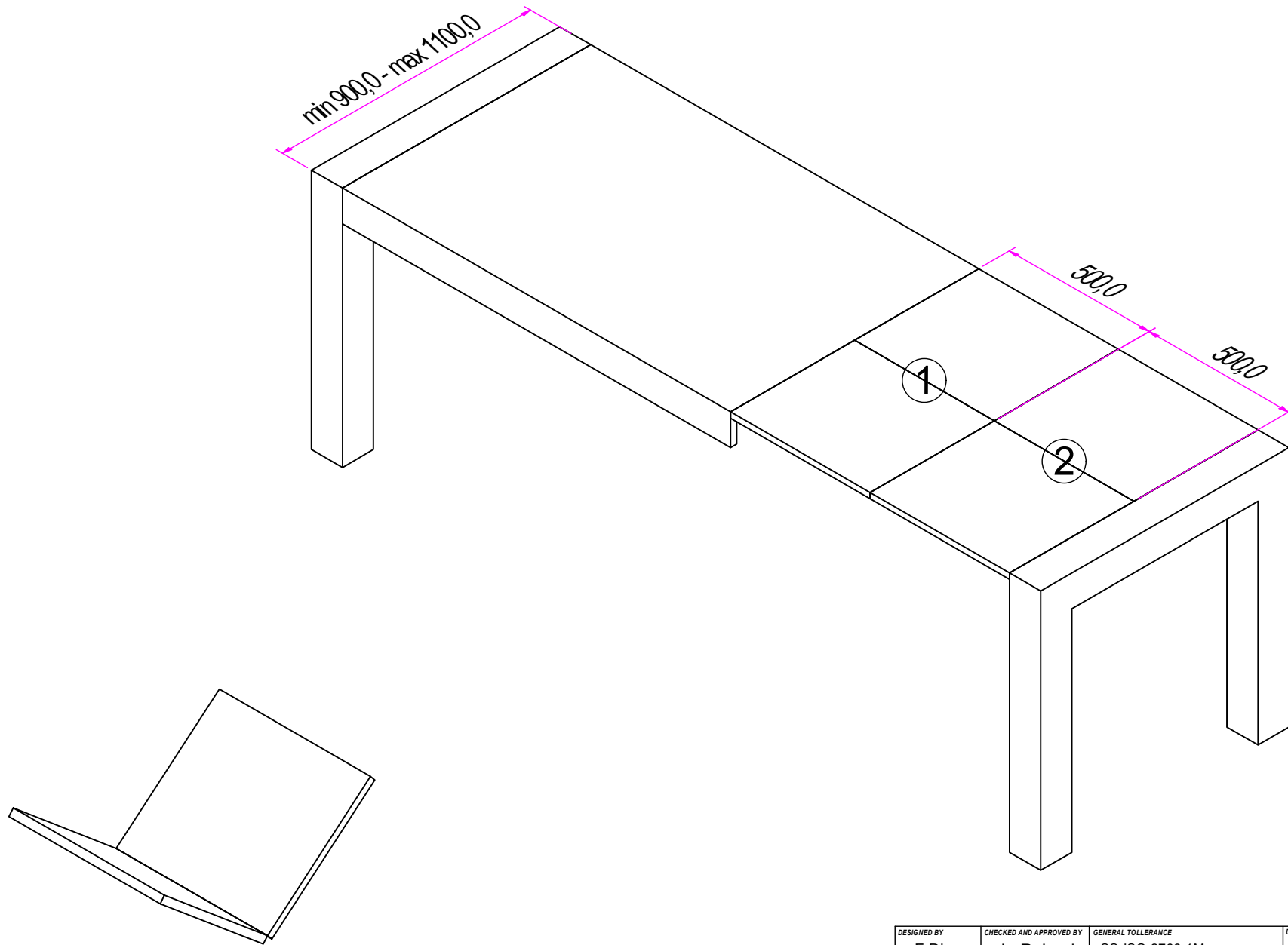

DESIGNED BY F.Dino	CHECKED AND APPROVED BY L. Paleari	GENERAL TOLLERANCE SS-ISO-2768-1M	DATE 10/10/2018	CODE T621300B
	PACKAGING Carton 1 piece	UNIT mm	SHEET 4 of 4	
	DESCRIPTION Single extension	MATERIAL Anodise aluminum alloy 6060		
	DEVICE	PAIR WEIGHT 11 Kg	021	

Property of RAM Industrie.
Without its written authorization the present drawing shall neither be used for construction anyway, communicated to third parties, nor reproduced.