

DESIGNED BY F.Dino	CHECKED AND APPROVED BY L. Paleari	GENERAL TOLERANCE SS-ISO-2768-1M	DATE 06/10/2020	CODE T9011710
PACKAGING Carton 1 piece			UNIT mm	SHEET 1 of 6
		DESCRIPTION	MATERIAL Anodise aluminum alloy 6060	
		DEVICE	PAIR WEIGHT WITH CARTON	

Property of RAM Industrie.  
Without its written authorization the present drawing shall neither be used for construction anyway, communicated to third parties, nor reproduced.

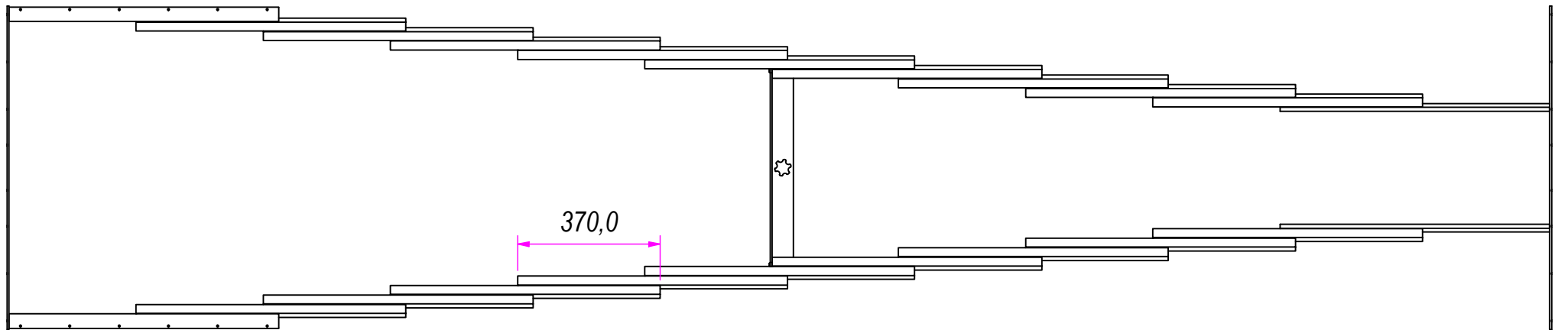

A ( 1 : 2.5 )

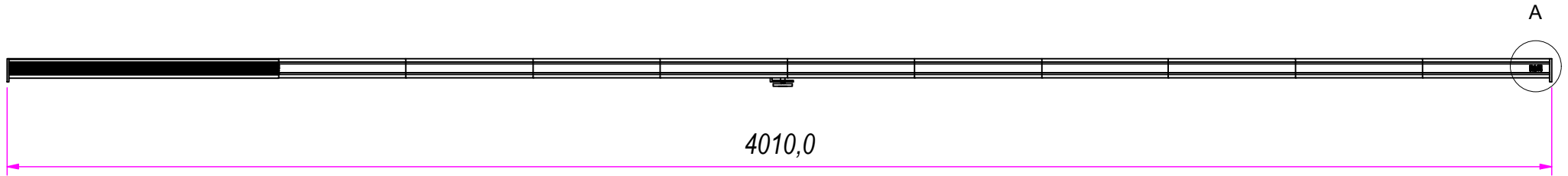
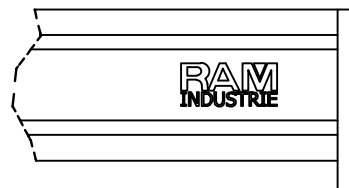

DESIGNED BY F.Dino	CHECKED AND APPROVED BY L. Paleari	GENERAL TOLLERANCE SS-ISO-2768-1M	DATE 06/10/2020	CODE T9011710
			PACKAGING	UNIT mm
			DESCRIPTION	SHEET 2 of 6
DEVICE		PAIR WEIGHT WITH CARTON		

Property of RAM Industrie.  
Without its written authorization the present drawing shall neither be used for construction anyway, communicated to third parties, nor reproduced.

1

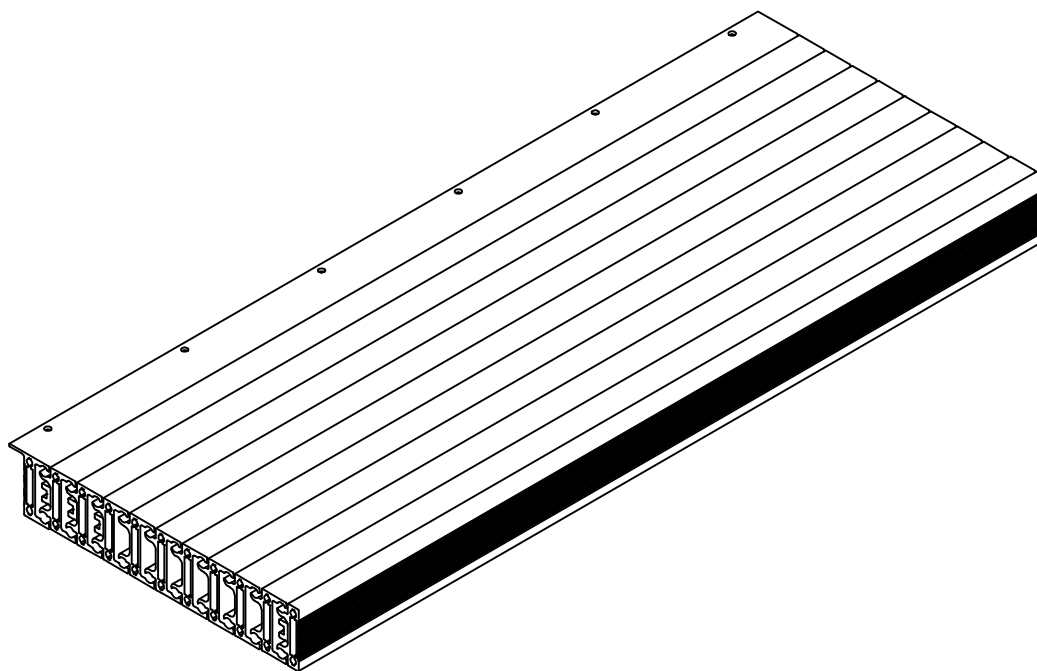
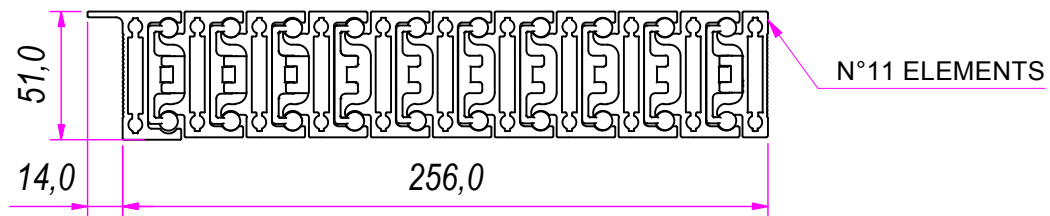

DESIGNED BY F.Dino	CHECKED AND APPROVED BY L. Paleari	GENERAL TOLERANCE SS-ISO-2768-1M	DATE 06/10/2020	CODE Guida
PACKAGING			UNIT mm	SHEET 3 of 6
DESCRIPTION <b>RAM INDUSTRIE</b>		MATERIAL Anodise aluminum alloy 6060		
DEVICE		PAIR WEIGHT WITH CARTON		

Property of RAM Industrie.  
Without its written authorization the present drawing shall neither be used for construction anyway, communicated to third parties, nor reproduced.

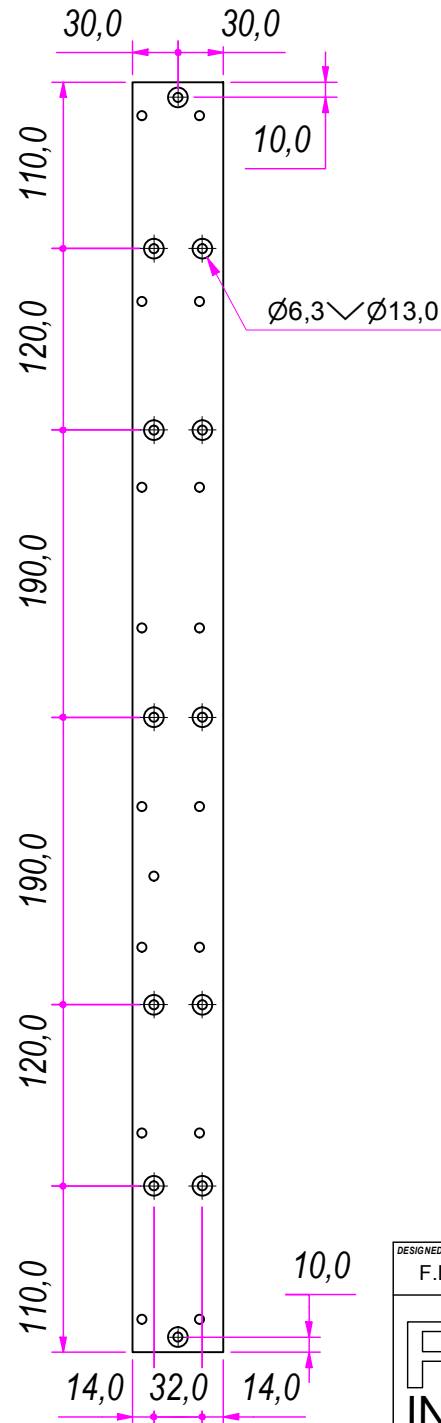
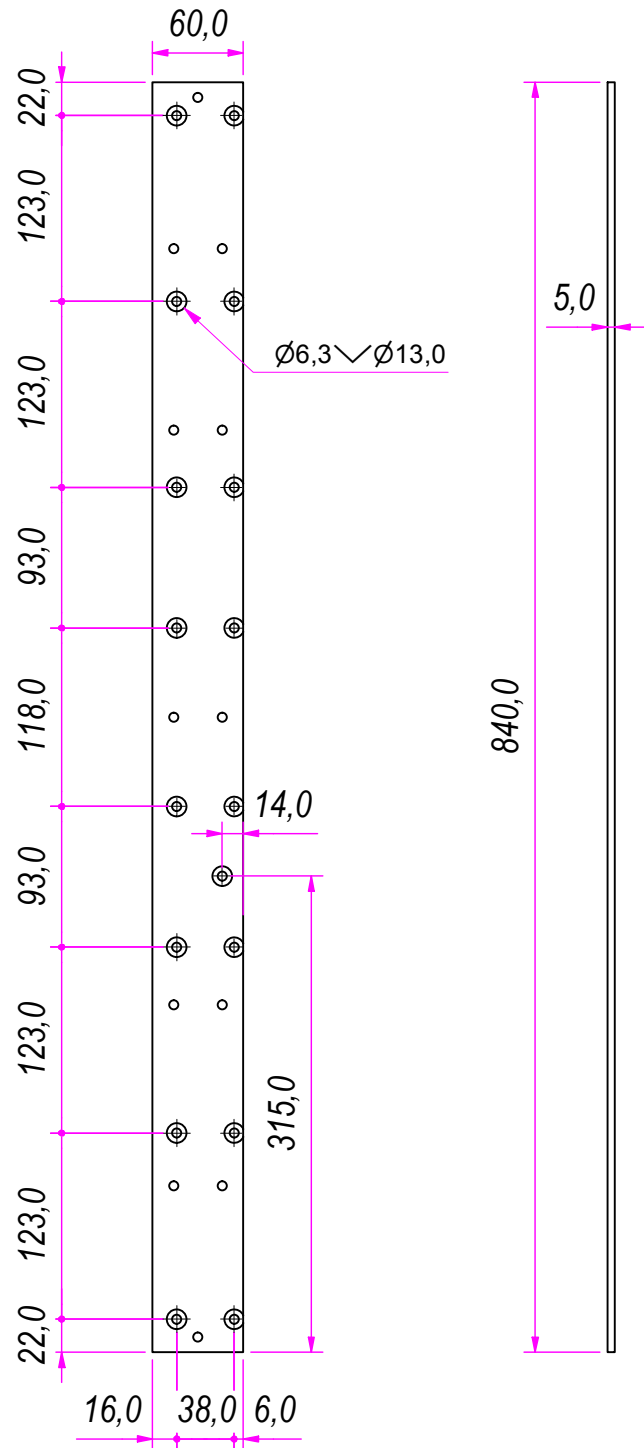

2

DESIGNED BY F.Dino	CHECKED AND APPROVED BY L. Paleari	GENERAL TOLERANCE SS-ISO-2768-1M	DATE 06/10/2020	CODE Piastra
PACKAGING			UNIT mm	SHEET 4 of 6
DESCRIPTION Black finishing		MATERIAL Iron		
DEVICE		PAIR WEIGHT WITH CARTON		

**RAM**  
INDUSTRIE

3

513,0

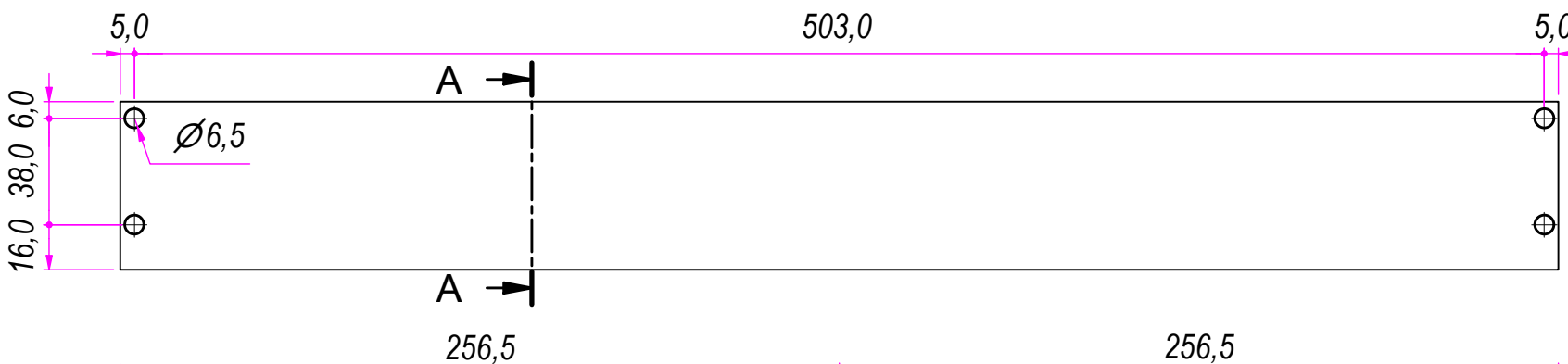
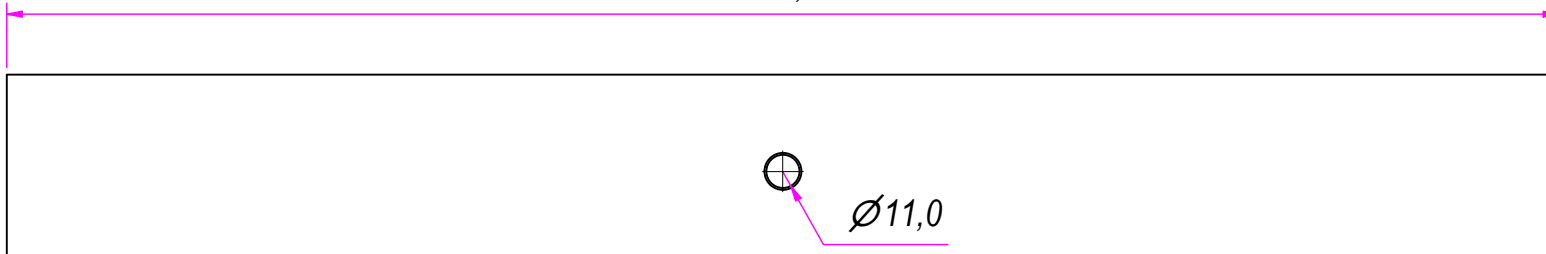

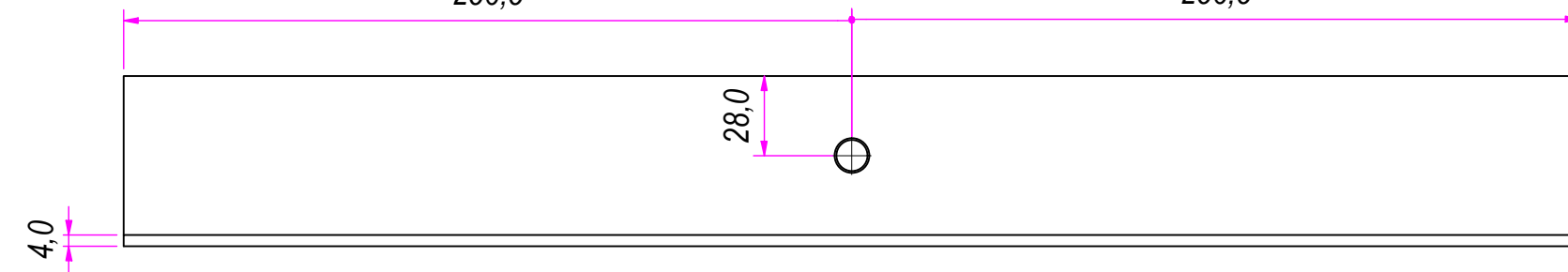
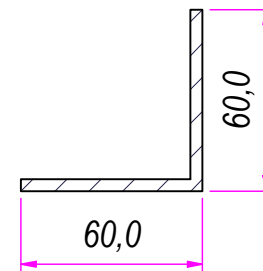

SEZ. A-A

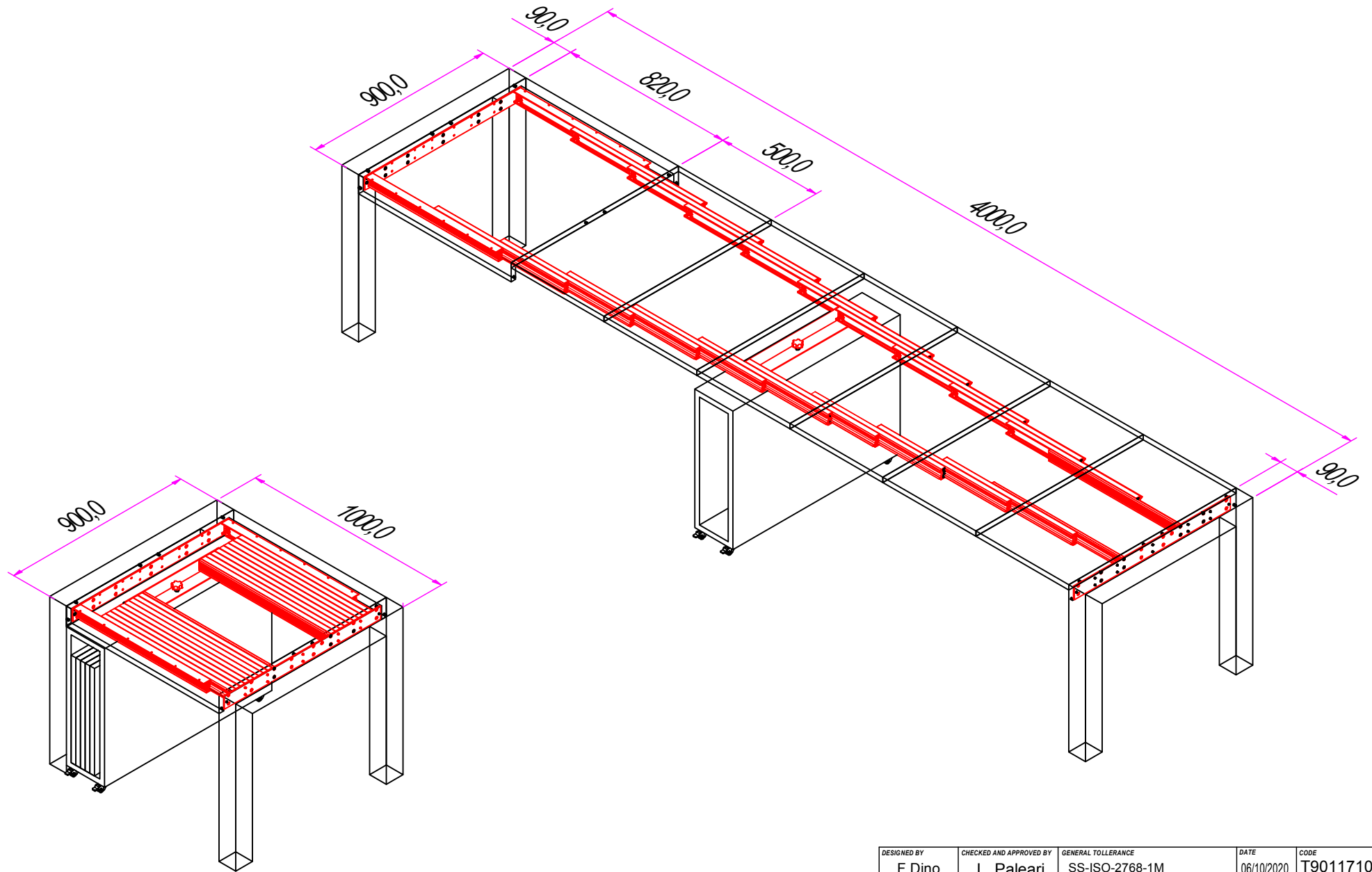

DESIGNED BY F.Dino	CHECKED AND APPROVED BY L. Paleari	GENERAL TOLLERANCE SS-ISO-2768-1M	DATE 06/10/2020	CODE Poggia gamba
<b>RAM</b> INDUSTRIE		PACKAGING	UNIT mm	SHEET 5 of 6
		DESCRIPTION	MATERIAL Aluminum	
		DEVICE	PAIR WEIGHT WITH CARTON	

Property of RAM Industrie.  
Without its written authorization the present drawing shall neither be used for construction anyway, communicated to third parties, nor reproduced.



DESIGNED BY F.Dino	CHECKED AND APPROVED BY L. Paleari	GENERAL TOLLERANCE SS-ISO-2768-1M	DATE 06/10/2020	CODE T9011710	
			PACKAGING	UNIT mm	SHEET 6 of 6
			DESCRIPTION	MATERIAL	
DEVICE		PAIR WEIGHT WITH CARTON			

Property of RAM Industrie.  
Without its written authorization the present drawing shall neither be used for construction anyway, communicated to third parties, nor reproduced.