

SEZ. A-A

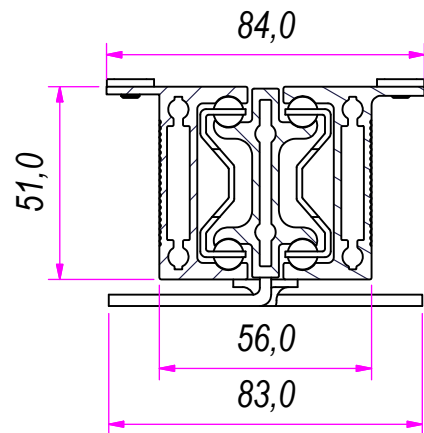

B (1 : 2.5)

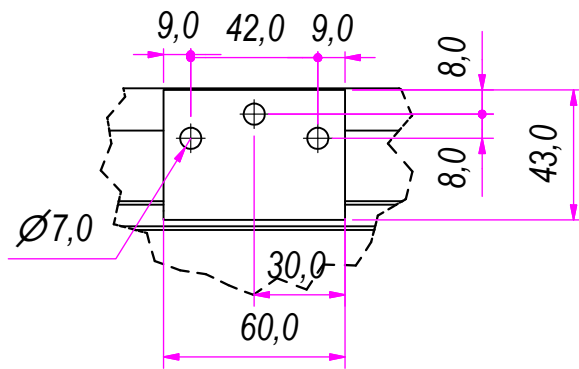

C (1 : 1)

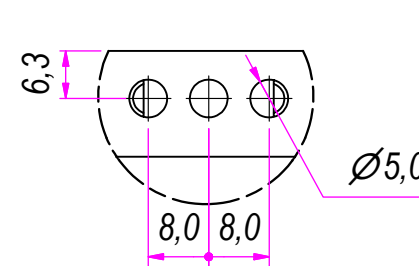

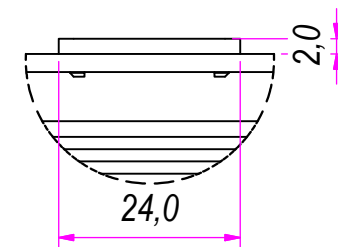

D (1 : 1)



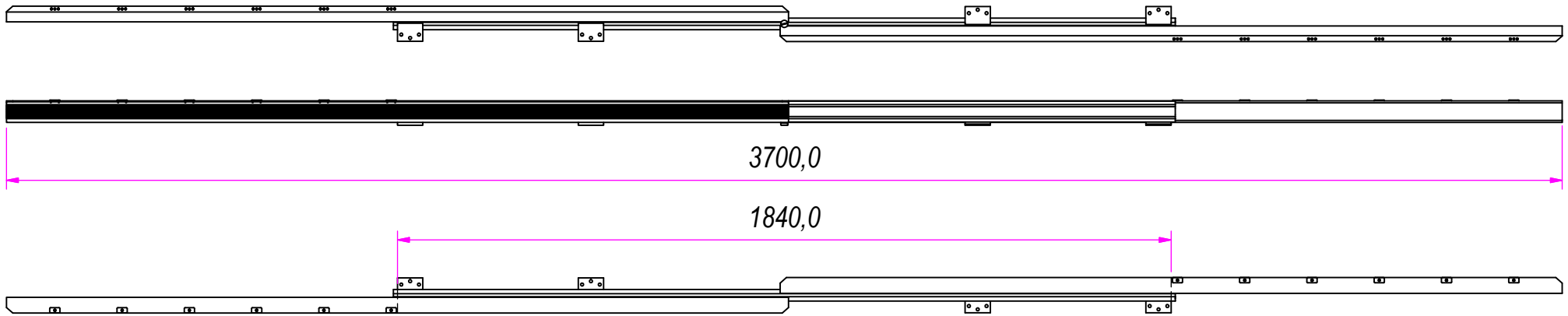

DESIGNED BY Assia	CHECKED AND APPROVED BY Loris	DATE 28.03.2024	CODE T971860
	GENERAL TOLERANCE SS-ISO-2768-1M	UNIT	SCALE 1/3
	DESCRIPTION	MATERIAL Anodise aluminium alloy 6060	
	DEVICES	PAIR WEIGHT	

Property of Ram Industrie
without its written authorization, the present drawing shall neither
be used for construction anyway, communicated to third parts, not reproduced

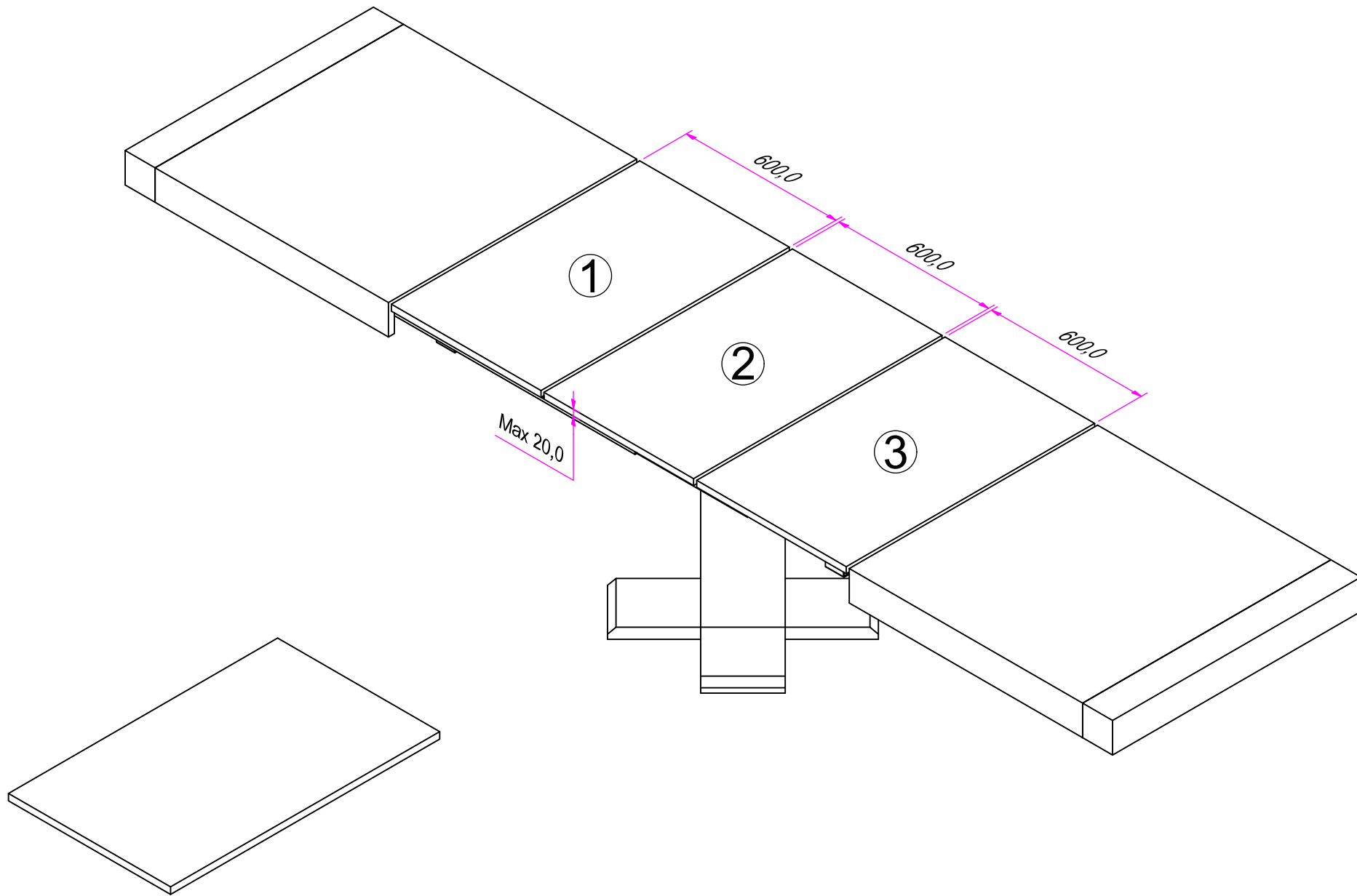

DESIGNED BY Assia	CHECKED AND APPROVED BY Loris	DATE 28.03.2024	CODE T971860
	GENERAL TOLLERANCE SS-ISO-2768-1M	UNIT	SCALE 2/3
	DESCRIPTION	MATERIAL Anodise aluminium alloy 6060	
DEVICES	PAIR WEIGHT		
<small>Property of Ram Industrie without its written authorization, the present drawing shall neither be used for construction anyway, communicated to third parts, not reproduced</small>			



DESIGNED BY Assia	CHECKED AND APPROVED BY Loris	DATE 28.03.2024	CODE T971860
	GENERAL TOLLERANCE SS-ISO-2768-1M	UNIT	SCALE SHEET 3/3
	DESCRIPTION	MATERIAL Anodise aluminium alloy 6060	
	DEVICES	PAIR WEIGHT	
<small>Property of Ram Industrie without its written authorization, the present drawing shall neither be used for construction anyway, communicated to third parts, not reproduced</small>			